

Armarios

Reach Ins / Armoires

3

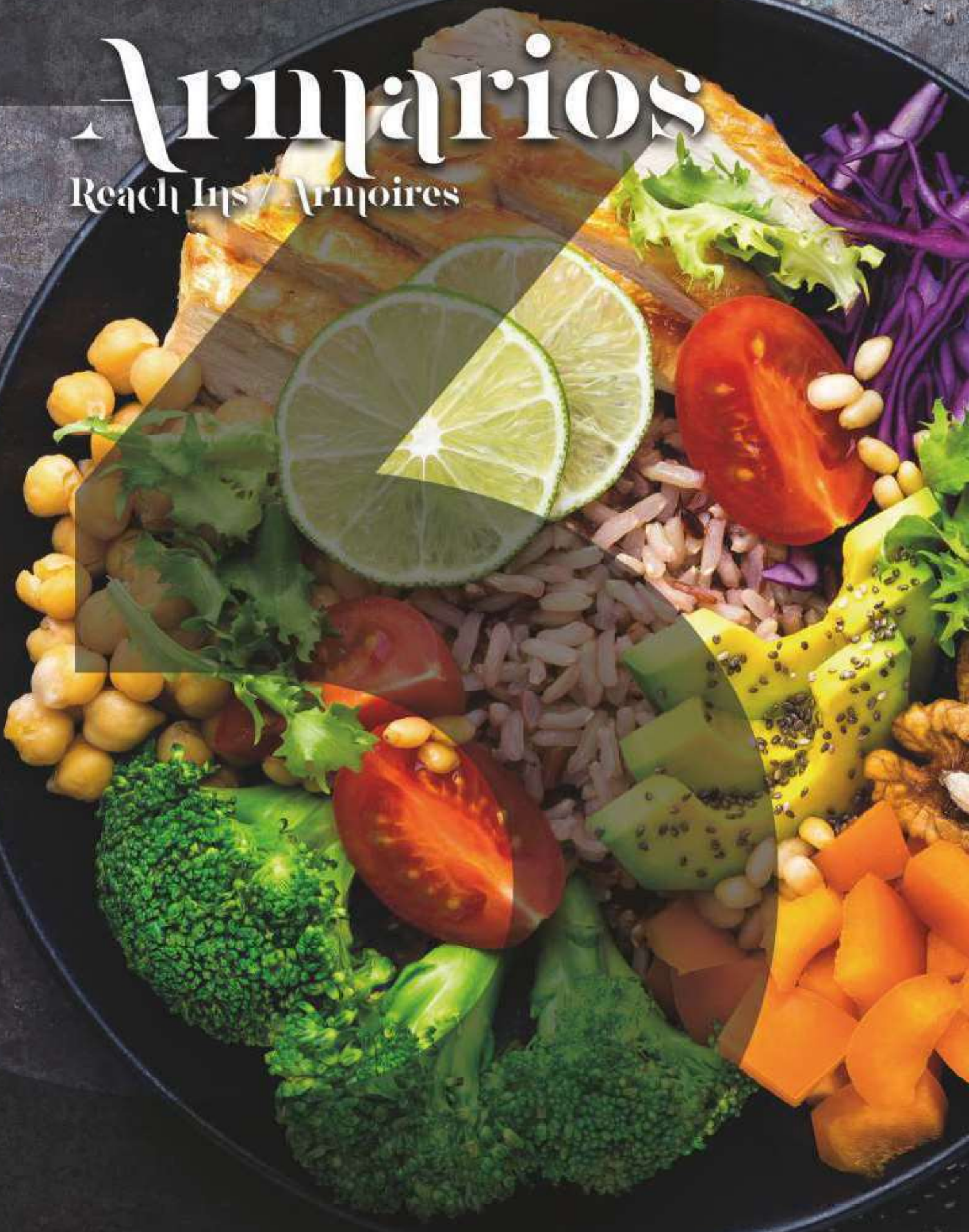



Serie / Series / Série

NACIONAL 400/900L

AN T/F
AN BT
AN CR
AP T/F



106-109

Serie / Series / Série

NACIONAL 500/1000L

AN T/F
AN BT
AN MX
AN DP TF/G
AN DP TF
AEX T/F
AN BT CR



110-115

Serie / Series / Série

NACIONAL 1600L

AN T/F



116-117

Serie / Series / Série

SLIM LINE 300/600L

AGN
AGN BT
AGN MX
AGN CR



118-119

Serie / Series / Série

AGB GN2/1 600/1300L

AGB
AGB BT



120-121

Serie / Series / Série

AGB GN2/1 700/1400L

AGB
AGB BT
AGB MX
AGB CR
AGB CR BT
AGB PESC
AGB A
AGB PAST
AGB BT PAST



122-127

Serie / Series / Série

EURONORM 60/40-60/80 AGB900L

AGB
AGB BT



128-129

Serie / Series / Série

CATERING AC600L

AC R
AC BT



128-129

Serie / Series / Série

PROOFING FC900BT

FC BT
FC BT CR



130-131

Serie / Series / Série

ROLLING RIC

RIC
RIC TH



132-133

+Info: www.infrico.com



3. Armarios Reach Ins / Armoires

Controlador digital táctil e intuitivo IP 65.

Digital control easy and intuitive—touch screen IP65 protection.

Contrôleur digital tactile e intuitif IP 65.



Doble acristalamiento templado, bajo emisoro con carga de Argón [4-27-4].

Double tempered glass, low-e with argon charge [4-27-4].

Double vitrage et verre trempé [4-27-4].



Iluminación / Lighting / Éclairage

Incorporación de iluminación LED, llegando a reducir el consumo energético entre un 80% y 90%, respecto a una bombilla tradicional. RGB opcional.

LED lighting incorporated, reducing energetic consumption between 80% and 90% respect to a traditional lighth bulb. RGB optional.

Éclairage LED, réduisant la consommation énergétique entre 80% et 90%, par rapport à une ampoule traditionnelle. RGB optionnel.

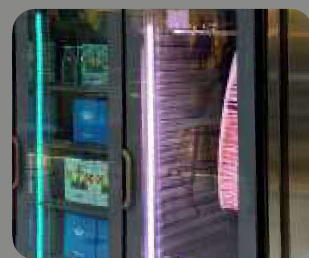

+Info: www.infrico.com

Monoblock



Puertas con tirador de doble agarre y burlete plano desmontable "cleanless".
Double handle doors and flat gasket easily removable "cleanless".
Portes avec double poignée et joint plat facilement démontable "cleanless".



Opcional: Manejo del control digital por WiFi o  Bluetooth®

Optional: Operating digital control by WiFi or  Bluetooth®

Optionnel: Fonctionnement de la commande numérique par WiFi ou  Bluetooth®

Opcional: Pata marina

Optional: Marine leg

Optionnel: Pied marin



Armarios de refrigeración y congelación Euronorm 600x400 / Euronorm 600x400 reach in refrigerator and freezer / Armoire Euronorme 600x400 positive et négative

REFRIG / REFRIG / POSIT

CONGEL / FREEZ / NÉGAT

REFRIG / REFRIG / POSIT

MODELO
MODELE
MODÈLE

AN 401 T/F

AN 902 T/F

AN 904 T/F

AN 401 BT

AN 902 BT

AN 401 CR

AN 902 CR

Precio Price Prix							
Medidas Measures (mm) Mesures	557 x 775 x 2060	1124 x 775 x 2060	1124 x 775 x 2060	557 x 775 x 2060	1124 x 775 x 2060	557 x 775 x 2060	1124 x 775 x 2060
Temperatura Temperature Température	-2°C/+8°C			-18°C		-2°C/+8°C	
Clase Climática Climatic class Classe climatique	5 / 40°C			4 / 38°C		5 / 40°C	
Tensión/Frecuencia Electrical data Tension électrique	230V/1ph/50Hz						
Controlador Controller Régulateur	Digital IP65						
Material Material (EXT/INT) Matériel	AISI 304						
Espesor Thickness Épaisseur	55						
Aislamiento Isolation Isolation	40kg/m ³ / Free CFC's / Zero ODP-GWP						
Capacidad Capacity Capacité	395	895	895	395	895	395	895
Puertas Doors Portes	1	2	4	1	2	1	2
N° parrillas / Guías N° shelves / Slides N° de grilles / Glissière	3/3 [600x400]	6/6 [600x400]		3/3 [600x400]	6/6 [600x400]	3/3 [600x400]	6/6 [600x400]
Sistema de frío Cooling System Système de froid	Forzado / Forced air / Ventilé						
Desescarche Defrost Dégivrage	Parada de compresor / Compresor off / Arrêt du compresseur			Gas caliente / Hot gas / Gaz chaud		Parada de compresor / Compresor off / Arrêt du compresseur	
Expansión Expansion Expansion	Capilar / Capillary / Capillaire			Válvula termostática / Expansion valve / Détendeur thermostatique		Capilar / Capillary / Capillaire	
Potencia Power Puissance	250	410		607	771	250	410
Potencia frig. Cooling capacity Puissance Frig.	370	690		540	720	370	690
Consumo Consumption Consommation	1,55	1,90		5,10	9,51	-	-
Clase energética Energy class Classe Énerg.	C	B		D		-	-
Refrigerante Refrigerant Gaz	R-290						
Opcional Optional Options	Parrilla / Wire shelf / Grille [502X26] Juego de guías / Slides / Jeu de Glissières [GUIAL0120595; GUIAL0220595] Cerradura / Lock / Serrure [506X209; 506X210] Manejo control digital por bluetooth / Operating digital control by bluetooth / Trait. de contrôle digital par bluetooth						
	115V/1ph/60Hz 230V/1ph/60Hz			115V/1ph/60Hz 230V/1ph/60Hz		115V/1ph/60Hz 230V/1ph/60Hz	

NEW

Serie / Series / Série **NACIONAL 400/900L**

+Info: www.infrico.com

AN 904 T/F



AN 401 CR



AN 401 T/F



AN 902 BT

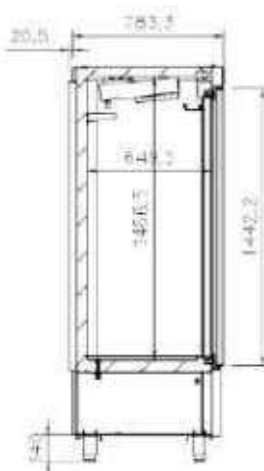

Controlador digital IP 65.
Digital control IP65
Contrôleur digital IP 65.



Armarios de refrigeración y congelación Pastelería y Pescado Euronorm 600x400 / Pastry and Fish Euronorm 600x400 reach in refrigerator and freezer / Armoire Euronorme 600x400 positive et négative pour la Pâtisserie et le Poisson

PASTELERÍA / PASTRY / PÂTISSERIE

PESCADO / FISH / POISSON

MODELO
MODELE
MODÈLE

AN 401 PAST

AN 902 PAST

AN 401 BT PAST

AN 902 BT PAST

AP 401 T/F

AP 902 T/F

Precio Price Prix						
Medidas Measures (mm) Mesures	557 x 775 x 2060	1124 x 775 x 2060	557 x 775 x 2060	1124 x 775 x 2060	557 x 775 x 2060	1124 x 775 x 2060
Temperatura Temperature Température	-2°C/+8°C		-18°C		-2°C/+2°C	
Clase Climática Climatic class Classe climatique	5 / 40°C		4 / 38°C		5 / 40°C	
Tensión/Frecuencia Electrical data Tension électrique	230V/1ph/50Hz					
Controlador Controller Régulateur	Digital IP65					
Material Material (EXT/INT) Matériel	AISI 304					
Espesor Thickness Épaisseur	55					
Aislamiento Isolation Isolation	40kg/m ³ / Free CFC's / Zero ODP-GWP					
Capacidad Capacity Capacité	395	895	395	895	395	895
Puertas Doors Portes	1	2	1	2	1	2
N° parrillas / Guías N° shelves / Slides N° de grilles / Glissière	0/18	0/36	0/18	0/36	7	14
Sistema de frío Cooling System Système de froid	Forzado / Forced air / Ventilé					
Desescarche Defrost Dégivrage	Parada de compresor / Compressor off / Arrêt du compresseur			Gas caliente / Hot gas / Gaz chaud		Parada de compresor / Compressor off / Arrêt du compresseur
Expansión Expansion Expansion	Capilar / Capillary / Capillaire			Válvula termostática / Expansion valve / Détendeur thermostatique		Capilar / Capillary / Capillaire
Potencia Power Puissance	250	410	607	771	250	410
Potencia frig. Cooling capacity Puissance Frig.	370	690	540	720	370	690
Consumo Consumption Consommation	1,55	1,90	5,10	9,51	1,55	1,90
Clase energética Energy class Classe Énerg.	C	B	D		C	B
Refrigerante Refrigerant Gaz	R-290					
Opcional Optional Options	Parrilla / Wire shelf / Grille [502X26] Juego de guías / Slides / Jeu de Glissières [GUIAL0120595; GUIAL0220595] Cerradura / Lock / Serrure [506X209; 506X210] Manejo control digital por bluetooth/ Operating digital control by bluetooth / Trait. de contrôle digital par bluetooth					
	Bandeja / Tray / Plateau 600x400 [A850P41]				Contenedor polipropileno / Polypropylene container / Container polypropylène [501X08]	
	115V/1ph/60Hz 230V/1ph/60Hz			115V/1ph/60Hz 230V/1ph/60Hz		115V/1ph/60Hz 230V/1ph/60Hz

Serie / Series / Série **NACIONAL 400/900L**
 Serie / Series / Série **AP T/F**

+Info: www.infrico.com

AP 401 T/F



Contenedor polipropileno
 Polypropylene container
 Container polypropylène



600mm x 400mm x 150mm

AN 902 PAST



Bandeja pastelería (opcional)
 Pasty tray (optional)
 Plateau Pâtisserie (optionnel)



AN 400 PAST



Opcional: Manejo control digital por WiFi o Bluetooth®
 Optional: Operating digital control by WiFi or Bluetooth®

Controlador digital IP 65.
 Digital control IP65
 Contrôleur digital IP 65.

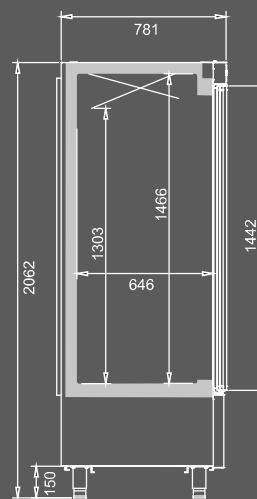

Armarios de refrigeración y congelación / Reach in refrigerator and freezer / Armoire positive et négative

REFRIG / REFRIG / POSIT

CONGEL / FREEZ / NÉGAT

REFRIG-CONGEL / REFRIG-FREEZER / POSIT-NÉGATIVE



MODELO
MODELE
MODÈLE

AN 501 T/F

AN 1002 T/F

AN 501 BT

AN 1002 BT

AN 502 T/F

AN 1003 T/F

AN 1004 T/F

Precio Price Prix							
Medidas Measures (mm) Mesures	687 x 700 x 2060	1385 x 700 x 2060	687 x 700 x 2060	1385 x 700 x 2060	687 x 700 x 2060	1385 x 700 x 2060	1385 x 700 x 2060
Temperatura Temperature Température	-2°C/+8°C		-18°C		-2°C/+8°C		
Clase Climática Climatic class Classe climatique	5 / 40°C		4 / 38°C		5 / 40°C		
Tensión/Frecuencia Electrical data Tension électrique	230V/1ph/50Hz						
Controlador Controller Régulateur	Digital IP65						
Material Material (EXT/INT) Matériel	AISI 304						
Espesor Thickness Épaisseur	55						
Aislamiento Isolation Isolation	40kg/m ³ / Free CFC's / Zero ODP-GWP						
Capacidad Capacity Capacité	500	1110	500	1110	500	1110	1110
Puertas Doors Portes	1	2	1	2	2	3	4
N° parrillas / Guías N° shelves / Slides N° de grilles / Glissière	3/3 (530x460)	6/6 (530x510)	3/3 (530x460)	6/6 (530x510)	3/3 (530x460)	6/6 (530x510)	6/6 (530x510)
Sistema de frío Cooling System Système de froid	Forzado / Forced air / Ventilé						
Desescarche Defrost Dégivrage	Parada de compresor / Compressor off / Arrêt du compresseur		Gas caliente / Hot gas / Gaz chaud		Parada de compresor / Compressor off / Arrêt du compresseur		
Expansión Expansion Expansion	Capilar / Capillary / Capillaire			Válv. Expansión/ Expansion valve/ Valve d'expansion	Capilar / Capillary / Capillaire		
Potencia Power Puissance	250	415	610	795	250	420	
Potencia frig. Cooling capacity Puissance Frig.	370	690	540	720	370	690	
Consumo Consumption Consommation	1,45	2,53	5,72	10,70	1,45	2,53	
Clase energética Energy class Classe Énerg.	C	B	D		C	B	
Refrigerante Refrigerant Gaz	R-290						
Opcional Optional Options	Parrilla / Wire shelf / Grille AN 500 [502X04] Parrilla / Wire shelf / Grille AN 1000 [502X02] Juego de guías / Slides AN 500 [GUIAC0315470] Juego de guías / Slides GUIAC0115520; GUIAC0215520 Ruedas / Casters / Roulettes (705X16=2; 705X17=2)			Cerradura / Lock / Serrure Manejo control digital wifi/ Operating digital control wifi / Trait. de contrôle digital wifi Barra carnicera / Meat bar set / Barre à viande [BCAN]			
	115V/1ph/60Hz 230V/1ph/60Hz		115V/1ph/60Hz 230V/1ph/60Hz		115V/1ph/60Hz 230V/1ph/60Hz		

Serie / Series / Série **NACIONAL 500/1000L**

+Info: www.infrico.com

AN 1003 T/F



AN 501 BT



AN 1002 T/F

Nuevo Controlador digital IP 65.
New Digital control IP65
Contrôleur digital IP 65.



Bisagra reforzada
Reinforced hinge
Charnière renforcée

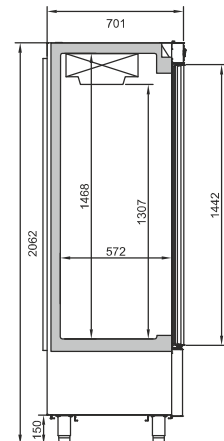
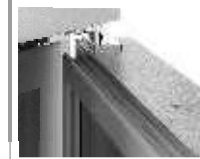

Armarios de refrigeración, congelación y mixtos / Reach in refrigerator, freezer and dual temperature / Armoires positives, négatives et mixtes

CONGELACIÓN / FREEZER / NÉGATIVE

MIXTO / DUAL TEMP / MIXTE

PESCADO / FISH / POISSON



MODELO
MODELE
MODÈLE

MODELO MODELE MODÈLE	AN502 BT	AN1003 BT	AN1004 BT	AN502 MX	AN1002 MX	ANDP1003 TF/G	ANDP1004 TF/G	ANDBT1003 TF	ANDBT1004 TF
Precio Price Prix									
Medidas Measures (mm) Mesures	687 x 700 x 2060	1385 x 700 x 2060	1385 x 700 x 2060	687 x 700 x 2060	1385 x 700 x 2060	1385 x 700 x 2060	1385 x 700 x 2060	1385 x 700 x 2060	1385 x 700 x 2060
Temperatura Temperature Température		-18°C		-2°C/+8°C -18°C		-2°C/+8°C -2°C/+2°C		-2°C/+8°C -18°C	
Clase Climática Climatic class Classe climatique	4 / 38°C					5 / 40°C		4 / 38°C	
Tensión/Frecuencia Electrical data Tension électrique	230V/1ph/50Hz								
Controlador Controller Régulateur	Digital IP65								
Material Material (EXT/INT) Matériel	AISI 304								
Espesor Thickness Épaisseur	55								
Aislamiento Isolation Isolation	40kg/m ³ / Free CFC's / Zero ODP-GWP								
Capacidad Capacity Capacité	500	1110		240/240	540/540	245/855			
Puertas Doors Portes	2	3	4	2		3	4	3	4
N° parrillas / Guías N° shelves / Slides N° de grilles / Glissière	3/3 [530x460]	6/6 [530x510]	6/6 [530x510]	3/3 [530x460]	6/6 [530x510]	3 Cont. 4 Parr./Shel./Gril.		6 Parr./Shel./Gril.	
Sistema de frío Cooling System Système de froid	Forzado / Forced air / Ventilé								
Desescarche Defrost Dégivrage	Gas caliente / Hot gas / Gaz chaud			Parada comp(+)/Gas caliente(-) Compressor off(+)/Hot gas(-) Arrêt compres(+)/Gaz chaud(-)		Parada de compresor / Compressor off / Arrêt du compresseur		Parada comp(+)/Gas caliente(-) Compressor off(+)/Hot gas(-) Arrêt compres(+)/Gaz chaud(-)	
Expansión Expansion Expansion	Capilar / Capillary / Capillaire	Válv. Expansión/ Expansion valve/ Détendeur thermostatique			Capilar / Capillary / Capillaire				
Potencia Power Puissance	610	795		1003	1090	589		1050	
Potencia frig. Cooling capacity Puissance Frig.	540	720		370 / 445	370 / 540	690 / 370		690 / 445	
Consumo Consumption Consommation	5,72	10,70		4,84	7,91	-	-	-	-
Clase energética Energy class Classe Énerg.	D			-	-	-	-	-	-
Refrigerante Refrigerant Gaz	R-290								
Opcional Optional Options	Parrilla / Wire shelf / Grille AN 500 [502X04] Parrilla / Wire shelf / Grille AN 1000 [502X02] Juego de guías / Slides AN 500 [GUIAC0315470] Juego de guías / Slides AN 1000 [GUIAC0115520; GUIAC0215520] Barra carnicera / Meat bar set / Barre à viande (BCAN)					Cerradura / Lock / Serrure Manejo control digital wifi/ Operating digital control wifi / Trait. de contrôle digital wifi Ruedas / Casters / Roulettes [705X16=2; 705X17=2]			
	115V/1ph/60Hz 230V/1ph/60Hz					115V/1ph/60Hz 230V/1ph/60Hz		115V/1ph/60Hz 230V/1ph/60Hz	

Serie / Series / Série **NACIONAL 500/1000L**

+Info: www.infrico.com

AN 1003 BT



ANDP 1004 TF/G 

De serie: 3 contenedores de polipropileno en departamento de pescado
 Standard: 3 polypropylene containers in fish department
 Standard : 3 conteneurs en polypropylène au rayon poisson

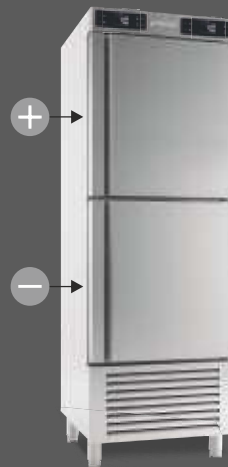

AN 502 MX

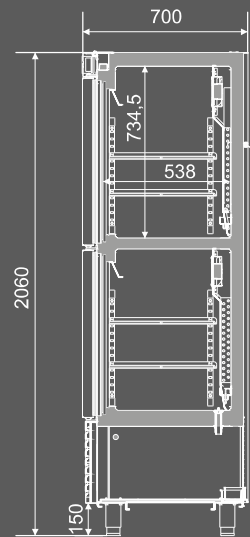

Armarios expositores refrigeración y congelación / Bottom mounted refrigerator and freezer glass door reach in / Armoires positives et négatives portes vitrées

REFRIGERACIÓN / REFRIGERATOR / POSITIVE

CONGELACIÓN / FREEZER / NÉGATIVE



AEX500 T/F



AEX1000 T/F



AEX1600 T/F



AN501 BT CR



AN1002 BT CR

MODELO
MODELE
MODÈLE

Precio Price Prix					
Medidas Measures (mm) Mesures	↔ ↕	687 x 700 x 2060 mm.	1385 x 700 x 2060 mm.	2081 x 700 x 2060 mm.	687 x 700 x 2060 mm.
Temperatura Temperature Température	[°C]	+2°C/+6°C			-18°C
Clase Climática Climatic class Classe climatique	[°C]	4 / 38°C			
Tensión/Frecuencia Electrical data Tension électrique		230V/1ph/50Hz			
Controlador Controller Régulateur		Digital IP65			
Material Material (EXT/INT) Matériel		AISI 304			
Espesor Thickness Épaisseur	(mm)	55			
Aislamiento Isolation Isolation	(mm)	40kg/m ³ / Free CFC's / Zero ODP-GWP			
Capacidad Capacity Capacité	[L]	500	1110	1730	500
Puertas Doors Portes		1	2	3	1
N° parrillas / Guías N° shelves / Slides N° de grilles / Glissière		4/4 (530x460)	8/8 (530x510)	12/12 (530x510)	4/4 (530x460)
Consumo Consumption Consommation	(kWh/ 24h)	-	-	-	8,60
Sistema de frío Cooling System Système de froid		Forzado / Forced air / Ventilé			
Desescarche Defrost Dégivrage		Parada de compresor / Compresor off / Arrêt du compresseur			Gas caliente / Hot gas / Gaz chaud
Expansión Expansion Expansion		Capilar / Capillary / Capillaire			Válvula de Expansión Termostática / Thermostatic expansion valve / Valve d'expansion Thermostatique
Potencia Power Puissance	[W]	270	455	615	755
Potencia frig. Cooling capacity Puissance Frig.	[W A -10°C]	390	690	950	723
Refrigerante Refrigerant Gaz		R-290			
Opcional Optional Options		Juego de guías / Slides AN 500 (GUIAC0315470) Juego de guías / Slides AN 1000 (GUIAC0115520; GUIAC0215520) Parrilla doble tupida / Dense wire shelf / Grilles AN 500 (502X90) Parrilla doble tupida / Dense wire shelf / Grilles AN 1000 (502X89) Cerradura / Lock / Serrure (506X60) Manejo control digital wifi / Operating digital control wifi / Trait. de contrôle digital wifi Iluminación Led RGB con cambio de color (por puerta) / Led lighting RGB change of colour (per door) / LED RGB avec changement de couleur (par porte)			
		115V/1ph/60Hz 230V/1ph/60Hz		115V/1ph/60Hz 230V/1ph/60Hz	

Serie / Series / Série **NACIONAL 500/1000L**

+Info: www.infrico.com

AEX 1000 T/F

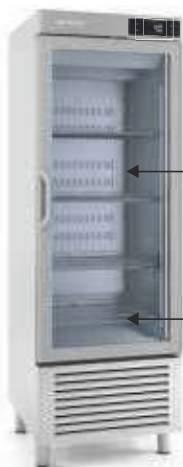

Triple acristalamiento templado, bajo emisivo con carga de Argón (4-12-3-12-4)
 Triple tempered glass, low emission with Argon charge (4-12-3-12-4)
 Triple vitrage trempé à faible émissivité avec Argon (4-12-3-12-4)

Parrilla reforzada
 Reinforced shelves
 Grille renforcée



Nuevo Controlador digital IP 65.
 New Digital control IP65
 Contrôleur digital IP 65.



AN 501 BT CR

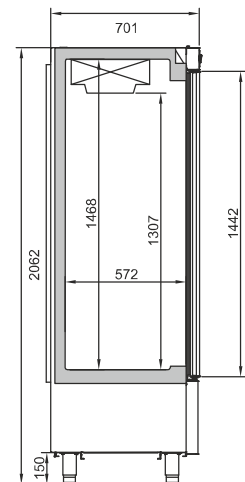

Armario de refrigeración / Bottom mounted refrigerator / Armoire positive

Armario de refrigeración GN1/1 / GN1/1 Reach in refrigerator / Armoire positive GN1/1

Serie / Series / Série **NACIONAL 1600L**

Serie / Series / Série **SLIM LINE 300/600L**

MODELO
MODELE
MODÈLE



AN1603 T/F



AN1605 T/F



AN1606 T/F



AGN301



AGN602

Precio Price Prix					
Medidas Measures (mm) Mesures	↔ ↕	2081 x 700 x 2060 mm.	2081 x 700 x 2060 mm.	2081 x 700 x 2060 mm.	482 x 695 x 2100 mm.
Temperatura Temperature Température	[°C]	-2°C/+8°C			-2°C/+8°C
Clase Climática Climatic class Classe climatique	[°C]	5 / 40°C			5 / 40°C
Tensión/Frecuencia Electrical data Tension électrique		230V/1ph/50Hz			
Controlador Controller Régulateur		Digital IP65			
Material Material (EXT/INT) Matériel		AISI 304			
Espesor Thickness Épaisseur	(mm)	55			
Aislamiento Isolation Isolation	(mm)	40kg/m ³ / Free CFC's / Zero ODP-GWP			
Capacidad Capacity Capacité	[L]	1730		325	745
Puertas Doors Portes		3	5	6	2
N° parrillas / Guías N° shelves / Slides N° de grilles / Glissière		9/9 (530x510)		3/3 (325x530)	6 / 6 (325x530)
Sistema de frío Cooling System Système de froid		Forzado / Forced air / Ventilé			
Desescarche Defrost Dégivrage		Parada de compresor / Compressor off / Arrêt du compresseur			
Expansión Expansion Expansion		Capilar / Capillary / Capillaire			
Potencia Power Puissance	[W]	420		237	402
Potencia frig. Cooling capacity Puissance Frig.	[W A -10°C]	690		370	690
Consumo Consumption Consommation	[kWh/ 24h]	3,60		1,40	1,85
Clase energética Energy class Classe Énerg.		B		C	
Refrigerante Refrigerant Gaz		R-290			
Opcional Optional Options		Juego de guías / Slides / Jeu de Glissières [GUIAC0115520; GUIAC0215520] Cerradura / Lock / Serrure [506X209; 506X210]		Manejo control digital bluetooth o wifi / Operating digital control bluetooth or wifi / Trait. de contrôle digital bluetooth ou wifi Ruedas/Casters/Roulettes [705X16=2; 705X17=2]	
		Parrilla / Wire shelf / Grille AN 1600 [502X04] Barra carnicera / Meat bar set / Barre à viande [BCAN]		Parrilla / Wire shelf / Grille [502X12]	
		115V/1ph/60Hz 230V/1ph/60Hz			

Serie / Series / Série **NACIONAL 1600L**
 Serie / Series / Série **SLIM LINE 300/600L**

+Info: www.infrico.com



AN 1606 T/F

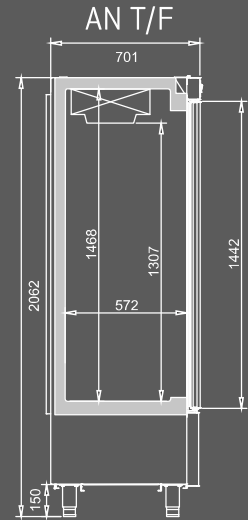

AGN 301

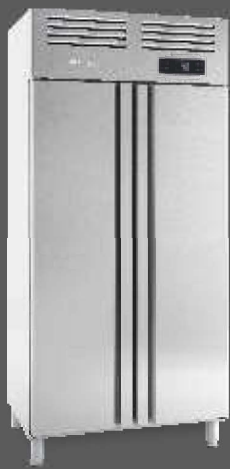

AGN 602

Controlador digital IP 65.
 Digital control IP65
 Contrôleur digital IP 65.



Opcional: Manejo control digital por WiFi o  Bluetooth®
 Optional: Operating digital control by WiFi or  Bluetooth®

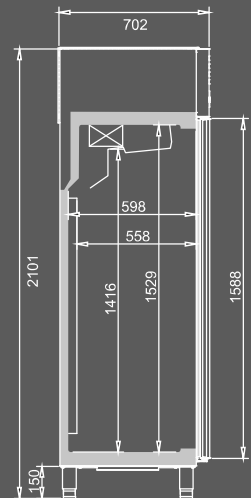

Armarios de refrigeración y congelación GN1/1 / GN1/1 Refrigerator and freezer reach in / Armoires positives et négatives GN1/1

CONGELACIÓN / FREEZER / NÉGATIVE

REFRIGERACIÓN / REFRIGERATOR / POSITIVE

REFRIG/REFRIG/POSIT

MODELO
MODELE
MODÈLE

AGN301 BT

AGN602 BT

AGN602 MX

AGN302

AGN603

AGN604

AGN300 CR

AGN600 CR

Precio Price Prix								
Medidas Measures (mm) Mesures	482 x 695 x 2100 mm.	974 x 695 x 2100 mm.	974 x 695 x 2100 mm.	482 x 695 x 2100 mm.	974 x 695 x 2100 mm.	974 x 695 x 2100 mm.	482 x 695 x 2100 mm.	974 x 695 x 2100 mm.
Temperatura Temperature Température	-18°C		-2°C/+8°C -18°C	-2°C/+8°C			+2°C/+6°C	
Clase Climática Climatic class Classe climatique	4 / 38°C			5 / 40°C			4 / 38°C	
Tensión/Frecuencia Electrical data Tension électrique	230V/1ph/50Hz							
Controlador Controller Régulateur	Digital IP65							
Material Material (EXT/INT) Matériel	AISI 304							
Espesor Thickness Épaisseur	55							
Aislamiento Isolation Isolation	40kg/m ³ / Free CFC's / Zero ODP-GWP							
Capacidad Capacity Capacité	325	745	325+325	325	745		325	745
Puertas Doors Portes	1	2		2	3	4	1	2
Nº parrillas / Guías Nº shelves / Slides Nº de grilles / Glissière	3/3 [325x530]	6/6 [325x530]		3/3 [325x530]	6/6 [325x530]		4/4 [325x530]	8/8 [325x530]
Sistema de frío Cooling System Système de froid	Forzado / Forced air / Ventilé							
Desescarche Defrost Dégivrage	Gas caliente / Hot gas / Gaz chaud		Parada comp(+)/Gas caliente(-) Compressor off(+)/Hot gas(-) Arrêt compres(+)/Gaz chaud(-)	Parada de compresor / Compressor off / Arrêt du compresseur				
Expansión Expansion Expansion	Válv. Expansión/ Expansion valve/ Détendeur thermostatique		Capilar(+)/V. Exp(-) Cap(+)/Exp. valve(-) Cap(+)/V. d'exp(-)	Capilar/ Capillary / Capillaire				
Potencia Power Puissance	550	725	772	237	406		252	456
Potencia frig. Cooling capacity Puissance Frig.	445	720	370 / 445	370	690		370	690
Consumo Consumption Consommation	4,83	9,22	-	1,40	1,85		-	
Clase energética Energy class Classe Energ.	D		-	C			-	
Refrigerante Refrigerant Gaz	R-290							
Opcional Optional Options	230V/1ph/60Hz		Manejo control digital bluetooth o wifi/ Operating digital control bluetooth or wifi / Trait. de contrôle digital bluetooth ou wifi				Juego de guías / Slides / Jeu de Glissières [GUIAC0115550; GUIAC0215550]	
	115V/1ph/60Hz			115V/1ph/60Hz				
	Parrilla / Wire shelf / Grille [502X12] Ruedas / Casters / Roulettes [705X16=2; 705X17=2] Cerradura / Lock / Serrure [506X209; 506X210]			Parrilla inoxidable / Stainless steel wire shelf / Grille Inox [502X46] Cerradura / Lock / Serrure [506X209; 506X210] Parrilla tupida / Extradense wire shelf / Grille renforcée [502X62] Ruedas / Casters / Roulettes [705X16=2; 705X17=2]				Parrilla tupida / Extradense wire shelf / Grille renforcée [502X62] Parrilla inox / Stainless steel wire shelf / Grille Inox [502X46] Cerradura/Lock/Serrure [506X60] Iluminación Led RGB con cambio de color (por puerta) / Led lighting RGB change of colour (par door) / LED RGB avec change- ment de couleur (par porte)

Serie / Series / Série **SLIM LINE 300/600L**

+Info: www.infrico.com

AGN 301 BT



AGN 604



AGN 600 CR

Doble acristalamiento templado, bajo emisivo con carga de Argón [4-27-4]
Double tempered glass, low emission with Argon charge [4-27-4]
Double vitrage trempé à faible émissivité avec Argon [4-27-4]

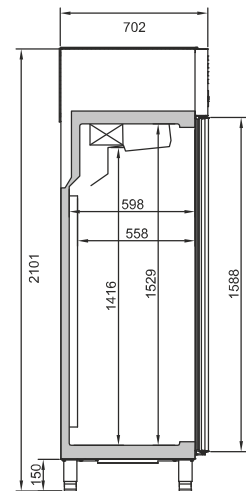

Armarios de refrigeración y congelación GN2/1 / GN2/1 Refrigerator and freezer reach in / Armoires positives et négatives GN2/1



AGB651



AGB1302



AGB651 BT



AGB1302 BT

MODELO
MODELE
MODÈLE

MODELO MODELE MODÈLE	AGB651	AGB1302	AGB651 BT	AGB1302 BT
Precio Price Prix				
Medidas Measures (mm) Mesures	687 x 794 x 1989 mm.	1385 x 794 x 1989 mm.	687 x 794 x 1989 mm.	1385 x 794 x 1989 mm.
Temperatura Temperature Température	-2°C/+8°C		-18°C	
Clase Climática Climatic class Classe climatique	5 / 40°C		4 / 38°C	
Tensión/Frecuencia Electrical data Tension électrique	230V/1ph/50Hz			
Controlador Controller Régulateur	Digital IP65			
Material Material (EXT/INT) Matériel	AISI 304			
Espesor Thickness Épaisseur	75			
Aislamiento Isolation Isolation	40kg/m ³ / Free CFC's / Zero ODP-GWP			
Capacidad Capacity Capacité	505	1120	505	1120
Puertas Doors Portes	1	2	1	2
Nº parrillas / Guías Nº shelves / Slides Nº de grilles / Glissière	3 (530x650)	6 (530x650)	3 (530x650)	6 (530x650)
Sistema de frío Cooling System Système de froid	MONOBLOCK Forzado / Forced air / Ventilé			
Desescarche Defrost Dégivrage	Parada compres./ Compresor off/ Arrêt compres.		Gas caliente / Hot gas / Gaz chaud	
Expansión Expansion Expansion	Capilar/ Capillary / Capillaire		Válv. Expansión/ Expansion valve/ Détendeur thermostatique	
Potencia Power Puissance	210	374	664	1054
Potencia frig. Cooling capacity Puissance Frig. -10/-30°C	370	690	583	1010
Consumo Consumption Consommation	1,41	2,40	7,12	13,11
Clase energética Energy class Classe Énerg.	C	C	D	D
Refrigerante Refrigerant Gaz	R-290			
Opcional Optional Options	Manejo control digital bluetooth o wifi / Operating digital control bluetooth or wifi / Trait. de contrôle digital bluetooth ou wifi Parrilla tupida / Extradense wire shelf / Grille renforcée [502X91] Ruedas / Casters / Roulettes [705X16=2; 705X17=2]			
	115V/1ph/60Hz 230V/1ph/60Hz		115V/1ph/60Hz 230V/1ph/60Hz	

Serie / Series / Série **AGB 600/1300L**

+Info: www.infrico.com

AGB 1302 BT



Medida para pasar bajo puertas estándar
Measurement to pass under standard doors
Mesure pour passer sous les portes standard

1989mm

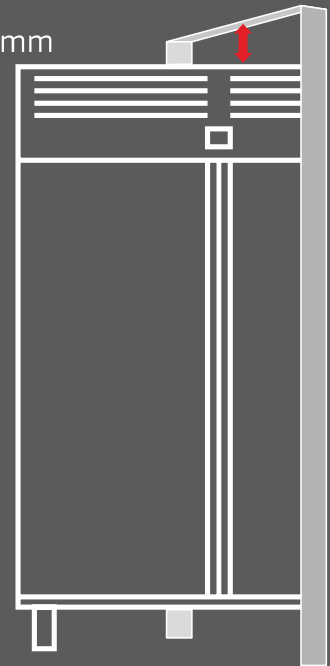

AGB 651

Cerradura de serie
Door lock included
Serrure de série

Costados con guías embutidas
End panels with embedded rails
Joues avec rails emboutis



Monoblock

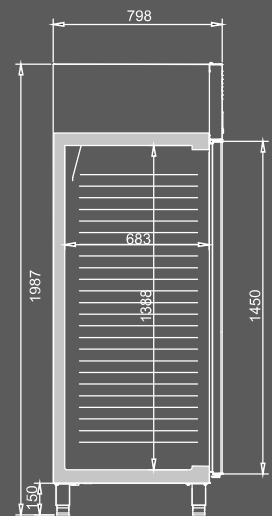

Armarios de refrigeración y congelación GN2/1 / GN2/1 Refrigerator and freezer reach in / Armoires positives et négatives GN2/1

REFRIGERACIÓN-CONGELACIÓN / REFRIGERATOR-FREEZER / POSITIVE-NÉGATIVE



MODELO
MODELE
MODÈLE

	AGB701	AGB1402	AGB701 BT	AGB1402 BT	AGB702	AGB702 BT	AGB1403	AGB1404
Precio Price Prix								
Medidas Measures (mm) Mesures	687 x 794 x 2130 mm.	1385 x 794 x 2130 mm.	687 x 794 x 2130 mm.	1385 x 794 x 2130 mm.	687 x 794 x 2130 mm.	687 x 794 x 2130 mm.	1385 x 794 x 2130 mm.	1385 x 794 x 2130 mm.
Temperatura Temperature Température	-2°C/+8°C		-18°C		-2°C/+8°C		-18°C	
Clase Climática Climatic class Classe climatique	5 / 40°C		4 / 38°C		5 / 40°C		4 / 38°C	
Tensión/Frecuencia Electrical data Tension électrique	230V/1ph/50Hz							
Controlador Controller Régulateur	Digital IP65							
Material Material (EXT/INT) Matériel	AISI 304							
Espesor Thickness Épaisseur	75							
Aislamiento Isolation Isolation	40kg/m ³ / Free CFC's / Zero ODP-GWP							
Capacidad Capacity Capacité	560	1240	560	1240	560		1240	
Puertas Doors Portes	1	2	1	2	2		3	4
N° parrillas / Guías N° shelves / Slides N° de grilles / Glissière	3 [530x650]	6 [530x650]	3 [530x650]	6 [530x650]	3 [530x650]		6 [530x650]	
Sistema de frío Cooling System Système de froid	MONOBLOCK Forzado / Forced air / Ventilé							
Desescarche Defrost Dégivrage	Parada compres./ Compresor off/ Arrêt compres.		Gas caliente / Hot gas / Gaz chaud		Parada compres./ Compresor off/ Arrêt compres.		Parada compres./ Compresor off/ Arrêt compres.	
Expansión Expansion Expansion	Capilar/ Capillary / Capillaire		Válv. Expansión/ Expansion valve/ Détendeur thermostatique		Capilar/ Capillary / Capillaire		Válv. exp. Termostát/ Thermost. exp. valve/ Détendeur thermos.	
Potencia Power Puissance	210	374	664	1054	210	664		371
Potencia frig. Cooling capacity Puissance Frig.	370	690	583	1010	370	583		690
Consumo Consumption Consommation	1,54	2,55	7,80	13,92	1,54	7,80		2,55
Clase energética Energy class Classe Énerg.	C	B	D		C	D	B	
Refrigerante Refrigerant Gaz	R-290							
Opcional Optional Options	Parrilla tupida / Extradense wire shelf / Grille renforcée [502X91] Barra carnicera / Meat bar set / Barre à viande [BCAN] Ruedas / Casters / Roulettes [705X16=2; 705X17=2] Manejo control digital bluetooth o wifi / Operating digital control bluetooth or wifi / Trait. de contrôle digital bluetooth ou wifi							
	115V/1ph/60Hz 230V/1ph/60Hz		115V/1ph/60Hz 230V/1ph/60Hz		115V/1ph/60Hz 230V/1ph/60Hz		115V/1ph/60Hz 230V/1ph/60Hz	

Serie / Series / Série **AGB 700/1400L**

+Info: www.infrico.com

AGB 1404



Nuevo Controlador digital IP 65.
New Digital control IP65
Contrôleur digital IP 65.



AGB 701



AGB 7U2 BI



Opcional: Manejo control digital por WiFi o Bluetooth®

Optional: Operating digital control by WiFi or Bluetooth®



Monoblock



Costados embutidos
Stamped inner sides
Intérieurs emboutis



Parrillas reforzadas
Reinforced wire shelves
Grilles renforcées

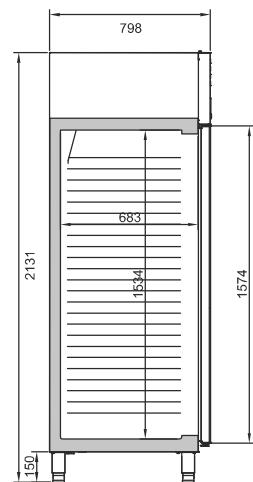

Armarios de refrigeración, congelación y mixtos GN2/1 /
GN2/1 Refrig, freezer and dual temp. reach in /
Armoires positives, négatives et mixtes GN2/1

Armarios de refrigeración, pescado 600x400 /
600x400 Fish refrigerator reach in /
Armoire positives 600x400 poisson

MIXTO / DUAL TEMP / MIXTE

REFRIG-CONGEL / REFRIG-FREEZER / POSIT-NÉGATIVE

PESCADO / FISH / POISSON



MODELO
 MODELE
 MODÈLE

AGN702 MX

AGB1402 MX

AGB701 CR

AGB1402 CR

AGB701 BT CR

AGB1402 BT CR

AGB701 PESC

AGB1402 PESC

Precio Price Prix										
Medidas Measures (mm) Mesures	↔ ↗ ↕	687 x 794 x 2130 mm.	1385 x 794 x 2130 mm.	687 x 794 x 2130 mm.	1385 x 794 x 2130 mm.	687 x 794 x 2130 mm.	1385 x 794 x 2130 mm.	687 x 794 x 2130 mm.	1385 x 794 x 2130 mm.	
Temperatura Temperature Température	[°C]	-2°C/+8°C -18°C		-2°C/+6°C		-18°C		-2°C/+2°C		
Clase Climática Climatic class Classe climatique	[°C]	4 / 38°C						5 / 40°C		
Tensión/Frecuencia Electrical data Tension électrique		230V/1ph/50Hz								
Controlador Controller Régulateur		Digital IP65								
Material Material (EXT/INT) Matériel		AISI 304								
Espesor Thickness Épaisseur	[mm]	75								
Aislamiento Isolation Isolation	[mm]	40kg/m ³ / Free CFC's / Zero ODP-GWP								
Capacidad Capacity Capacité	[L]	260/260	560/560	560	1240	560	1240	560	1240	
Puertas Doors Portes		2	2	1	2	1	2	1	2	
Nº parrillas / Guías Nº shelves / Slides Nº de grilles / Glissière		3 [530x650]	6 [530x650]	4 [530x650]	8 [530x650]	4 [530x650]	8 [530x650]	Nº contenedores / Containers 7	Nº contenedores / Containers 14	
Sistema de frío Cooling System Système de froid		Forzada / Forced air / Ventilé	MONOBLOCK Forzada / Forced air / Ventilé							
Desescarche Defrost Dégivrage		Parada compres. (+) Gas caliente (-) Compresor off (+) Hot gas (-) Arrêt compres. (+) Gaz chaud (-)	Parada de compresor / Compresor off / Arrêt du compresseur			Gas caliente / Hot gas / Gaz chaud		Parada compres./ Compresor off/ Arrêt compres.		
Expansión Expansion Expansion		Capilar (+) V. Exp (-) Cap (+) Exp. valve (-) Cap (+) Dét. Th. (-)	Capilar / Capillary / Capillaire				Válv. Expansión/ Expansion valve/ Détendeur thermostatique		Capilar/ Capillary / Capillaire	
Potencia Power Puissance	[W]	680	910	372	420	699	1550	210	374	
Potencia frig. Cooling capacity Puissance Frig.	[W A -10°C]	370 / 445	370 / 583	690		723	1446	370	690	
Consumo Consumption Consommation	[kWh/ 24h]	-							1,54	2,55
Clase energética Energy class Classe Énerg.		-							C	B
Refrigerante Refrigerant Gaz		R-290								
Opcional Optional Options		Manejo control digital bluetooth o wifi / Operating digital control bluetooth or wifi / Trait. de contrôle digital bluetooth ou wifi Ruedas / Casters / Roulettes (705X16=2; 705X17=2)				115V/1ph/60Hz 230V/1ph/60Hz				
		Parrilla / Wire shelf / Grille [502X91] Ruedas / Casters / Roulettes [705X16=2; 705X17=2] Juego de guías / Slides [GUIAL0320603] Barra carnicera / Meat bar set / Barre à viande [BCAN]			Parrilla / Wire shelf / Grille [502X91] Parrilla inoxidable / Stainless steel wire shelf / Grille Inox [502X58] Iluminación Led RGB con cambio de color [por puerta] / Led lighting RGB change of colour [per door] / LED RGB avec changement de couleur [par porte]			Juego de guías / Slides / Jeu de Glissières [GUIAL0125641; GUIAL0225641] Contenedor polipropileno / Polypropylene container / Conteneur de polypropylène [501X08] [501X08]		



Serie / Series / Série **AGB 700/1400L**

+Info: www.infrico.com

AGB 1402 BT CR



Controlador digital IP 65.
Digital control IP65
Contrôleur digital IP 65.



Parrillas reforzadas
Reinforced shelves
Grilles renforcées

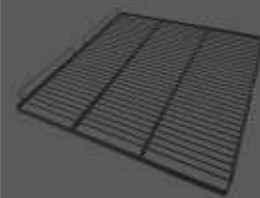

Triple acristalamiento templado,
bajo emisivo con carga de Argón
(4-12-3-12-4)

Triple tempered glass, low
emission with Argon charge
(4-12-3-12-4)

Triple vitrage trempé à faible
émissivité avec Argon
(4-12-3-12-4)



AGB PESC

Contenedor polipropileno
Polypropylene container
Conteneur de polypropylène



600mm x 400mm x 150mm

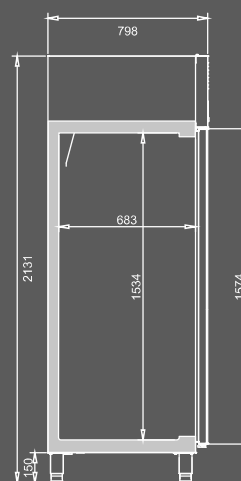

AGB 701 PESC



Armario refrig. GN2/1 GN2/1 refrigerator reach in / Armoire posit. GN2/1

Armario refrig. Euronorm 600x400 Pastelería / Euronorm 600x400 pastry reach in refriger. / Armoire posit. Euronorme 600x400 pâtisserie

AGB 700L INVERTER



AGB 701 A



AGB701 PAST

PASTELERÍA / PASTRY / PÂTISSERIE



AGB1402 PAST



AGB701 BT PAST



AGB1402 BT PAST

MODELO
MODELE
MODÈLE

Precio Price Prix						
Medidas Measures (mm) Mesures	↔ ↕	687 x 794 x 2130 mm.	687 x 794 x 2130 mm.	1385 x 794 x 2130 mm.	687 x 794 x 2130 mm.	1385 x 794 x 2130 mm.
Temperatura Temperature Température	[°C]	-2°C/+8°C	-2°C/+8°C		-18°C	
Clase Climática Climatic class Classe climatique	[°C]	5 / 40°C	5 / 40°C		4 / 38°C	
Tensión/Frecuencia Electrical data Tension électrique		230V/1ph/50Hz				
Controlador Controller Régulateur		Digital IP65				
Material Material (EXT/INT) Matériel		AISI 304				
Espesor Thickness Épaisseur	[mm]	75				
Aislamiento Isolation Isolation	[mm]	40kg/m ³ / Free CFC's / Zero ODP-GWP				
Capacidad Capacity Capacité	[L]	560	560	1240	560	1240
Puertas Doors Portes		1	1	2	1	2
Nº parrillas / Guías Nº shelves / Slides Nº de grilles / Glissière		3 (530x650)	0/18	0/36	0/18	0/36
Sistema de frío Cooling System Système de froid		MONOBLOCK		Forzado / Forced air / Ventilé		
Desescarche Defrost Dégivrage		Parada compres./ Compresor off/ Arrêt compres.	Parada de compresor / Compresor off / Arrêt du compresseur		Gas caliente / Hot gas / Gaz chaud	
Expansión Expansion Expansion		Válv. de expans. Electrónica / Electronic expansion valve / Valve d'expans. Electronique	Capilar/ Capillary / Capillaire		Válv. Expansión/ Expansion valve/ Détendeur thermostatique	
Potencia Power Puissance	[W]	110	210	420	683	1054
Potencia frig. Cooling capacity Puissance Frig.	[W A -10°C]	334	370	690	644	1010
Consumo Consumption Consommation	[kWh/ 24h]	0,94	1,54	2,55	7,80	13,92
Clase energética Energy class Classe Énerg.		A	C	B	D	D
Refrigerante Refrigerant Gaz		R-600a	R-290			
Opcional Optional Options		-	Manejo control digital bluetooth o wifi / Operating digital control bluetooth or wifi / Trait. de contrôle digital bluetooth ou wifi Ruedas / Casters / Roulettes [705X16=2; 705X17=2] Parrilla / Wire shelf / Grille [502X26] Juego de guías / Set of Slides / Jeu de Glissières [GUIAL0120641; GUIAL0220641] Bandeja / Tray / Plateau 600x400 [A850P41] Cerradura / Lock / Serrure [506X209; 506X210]			
			115V/1ph/60Hz 230V/1ph/60Hz		115V/1ph/60Hz 230V/1ph/60Hz	

+Info: www.infrico.com

AGB 701 A

Clase energ.
Energy class
Classe Énerg.

A+
INVERTER



Compresor de velocidad variable
Variable-capacity compressor
Compresseur vitesse variable



Costados embutidos
Stamped inner sides
Intérieurs emboutis



Parrillas reforzadas
Reinforced wire shelves
Grilles renforcées

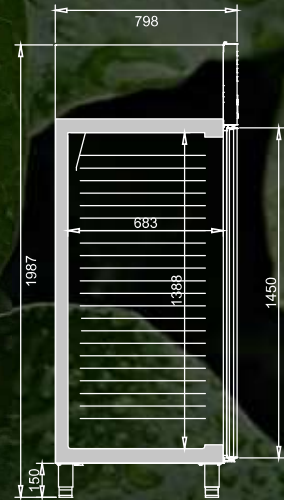

AGB 1402 BT PAST 

36 bandejas 600x400 (no incluidas)
36 trays 600x400 (not included)
36 plateaux 600x400 (non inclus)

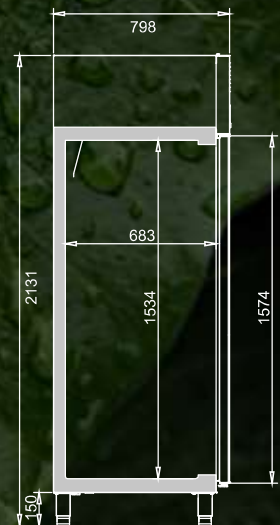



Opcional: Manejo control digital por WiFi o Bluetooth®
Optional: Operating digital control by WiFi or Bluetooth®

Armarios Euronorm 800x600 pastelería-heladería / Armario Cátering Euronorm 800x600 pastry-ice cream reach in / Catering reach in Armoire Euronorme 800x600 pâtisserie-glace / Armoire traiteur catering

HELADERÍA-PASTELERÍA / ICE CREAM-PASTRY / GLACE-PÂTISSERIE

Cátering / Catering / Catering



MODELO
MODELE
MODÈLE

AGB901

AGB901BT

AC600 R

AC600 BT

Precio Price Prix				
Medidas Measures (mm) Mesures	↔ ↕	796 x 960 x 2130 mm.	796 x 960 x 2130 mm.	750 x 752 x 1887 mm.
Temperatura Temperature Température	[°C]	-2°C/+8°C	-22°C/-25°C	0°C/+8°C
Clase Climática Climatic class Classe climatique	[°C]	5 / 40°C		4 / 38°C
Tensión/Frecuencia Electrical data Tension électrique		230V/1ph/50Hz		
Controlador Controller Régulateur		Digital IP65		
Material Material (EXT/INT) Matériel		AISI 304		AISI 430
Espesor Thickness Épaisseur	(mm)	75		60
Aislamiento Isolation Isolation	(mm)	40kg/m ³ / Free CFC's / Zero ODP-GWP		
Capacidad Capacity Capacité	[L]	785		542
Puertas Doors Portes		1		
Nº parrillas / Guías Nº shelves / Slides Nº de grilles / Glissière		6/6 (600X800)		3 (600X500)
Sistema de frío Cooling System Système de froid		MONOBLOCK Forzado / Forced air / Ventilé		Forzado / Forcé air / Ventilé
Desescarche Defrost Dégivrage		Parada compresor / Compresor off / Arrêt compresseur.	Gas caliente / Hot gas / Gaz chaud	Parada compresor / Compresor off / Arrêt compresseur.
Expansión Expansion Expansion		Capilar/ Capillary / Capillaire	Válv. expans. Termostática / Thermostatic expans. valve/ Valv. d'expans. Thermostatique	Capilar/ Capillary / Capillaire
Potencia Power Puissance	[W]	370	680	240
Potencia frig. Cooling capacity Puissance Frig.	[W A -10°C]	690	742	370
Consumo Consumption Consommation	[kWh/ 24h]	1,60	7,95	-
Clase energética Energy class Classe Énerg.		B	D	-
Refrigerante Refrigerant Gaz		R-290		
		115V/1ph/60Hz 230V/1ph/60Hz	115V/1ph/60Hz 230V/1ph/60Hz	115V/1ph/60Hz 230V/1ph/60Hz
Opcional Optional Options		Manejo control digital bluetooth o wifi / Operating digital control bluetooth or wifi / Trait. de contrôle digital bluetooth ou wifi Parrilla / Wire shelf / Grille (502X94) Bandeja / Tray / Plateau 600x400 (A850P41) Cubeta helados 5 L. / 5 L. ice cream tray / Bacs à glace 5 L. (501X32) Cerradura / Lock / Serrure (506X209)		Parrilla / Wire shelf / Grille (502X76) Ruedas / Casters / Roulettes (705X16; 705X17 =2) Contenedor / Container / Container 500x300x180mm (501X44) Contenedor / Container 600x400x220mm (501X45)

Serie / Series / Série **AGB 900L**
 Serie / Series / Série **AC 600L**

+Info: www.infrico.com

AGB 901 BT 



Capacidad 54 cubetas de helado de 5 L. [no incluidas]
Capacity 54 ice-cream 5 L. Trays [not included]
Capacité 54 bacs à glace 5 L. [non inclus]

AC 600 BT



Contenedor 600 x 400 mm de serie
Container 600 x 400 mm standard
Container 600 x 400 mm de série

Contenedor 500 x 300 mm de serie
Container 500 x 300 mm standard
Container 500 x 300 mm de série



AGB 901

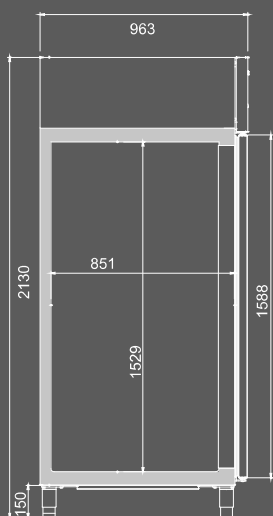

AC 600 BT

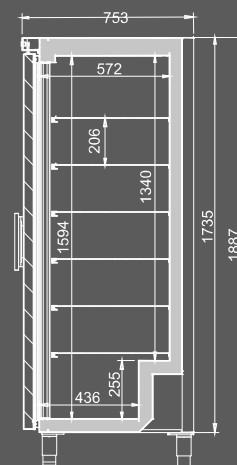

Armario Fermentación 600x800

Retarder proofer cabinet 600x800

Armoire de fermentation 600x800



FC900BT



FC900BT CR

MODELO
MODELE
MODÈLE

	FC900BT	FC900BT CR
Precio Price Prix		
Medidas Measures (mm) Mesures	796 x 960 x 2130 mm.	796 x 960 x 2130 mm.
Temperatura Temperature Température	-18°C/+35°C	
Clase Climática Climatic class Classe climatique	4 / 38°C	
Tensión/Frecuencia Electrical data Tension électrique	230V/1ph/50Hz	
Controlador Controller Régulateur	Digital IP65	
Material Material (EXT/INT) Matériel	AISI 304	
Espesor Thickness Épaisseur	75	
Aislamiento Isolation Isolation	40kg/m ³ / Free CFC's / Zero ODP-GWP	
Capacidad Capacity Capacité	785	
Puertas Doors Portes	1	
Nº parrillas / Guías Nº shelves / Slides Nº de grilles / Glissière	0/20	
Sistema de frío Cooling System Système de froid	Forzado / Forced air / Ventilé	
Desescarche Defrost Dégivrage	Gas caliente / Hot gas / Gaz chaud	
Expansión Expansion Expansion	Válv. expans. Termostática / Thermostatic expans. valve/ Valv. d'expans. Thermostatique	
Potencia Power Puissance	1762	
Potencia frig. Cooling capacity Puissance Frig.	Frío / Cool / Froid	1600
	Calor / Heat / Chauffé	750
Consumo Consumption Consommation	-	
Clase energética Energy class Classe Énerg.	-	
Refrigerante Refrigerant Gaz	R-290	
Opcional Optional Options	115V/1ph/60Hz 230V/1ph/60Hz	
	Manejo control digital bluetooth o wifi / Operating digital control bluetooth or wifi / Trait. de contrôle digital bluetooth ou wifi Parrilla / Grate / Grille 800X600 [502X94] Parrilla / Grate / Grille 600X400 [502X26] Juego guías/Slides/Jeu Glissières [GUIAL0120806; GUIAL0220806] Cerradura/Lock/Serrure [506X209] KIT Filtro agua / Water filter / Filtre à eau [4600x0018] Bandeja 600x400 / Tray 600x400 / Plateau 600x400	

Serie / Series / Série **FC 900 BT**

+Info: www.infrico.com

FC 900 BT CR



Humidificador
Humidifier
Humidificateur

Puerto USB
USB Connection
USB

Diseño interior con cremallera y guías
Interior design with zip and guides
Design intérieur avec serrure et glissières

Resistencia aleteada en acero inox
Stainless steel finned heater
Resistance à ailettes en Inox

FC 900 BT



Opción Kit filtro de agua
Option Kit water filter
Optionel Kit filtre à eau



Video del producto

Product Video
Vidéo du produit



Infrico Youtube

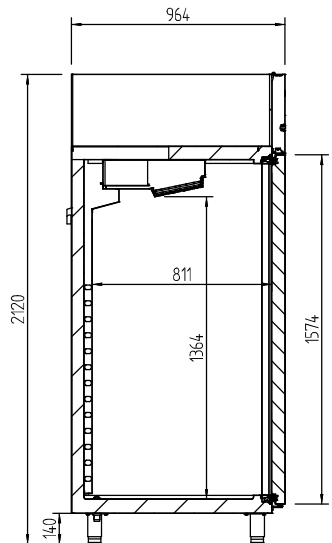

Cambiar tiempo de fin de ciclo
Change end of cycle time
Modifier la durée de fin de cycle



Cambiar valor de temperatura
Change temperature setpoint
Modifier la température de consigne



Cambiar valor de humedad
Change humidity setpoint
Modifier la valeur de l'humidité



Armarios para carros GN2/1, 600x400, 650x450, 800x600, 1300/2700L /
GN2/1, 600x400, 650x450, 800x600, 1300/2700L roll-in /
Armoire à chariot GN2/1, 600x400, 650x450, 800x600, 1300/2700L



RIC1P



RIC1P BT



RIC2P



RIC1P TH
Pasante/Pass-thru/Traversante

MODELO MODELE MODÈLE	RIC1P	RIC1P BT	RIC2P	RIC1P TH Pasante/Pass-thru/Traversante
Precio Price Prix				
Medidas Measures (mm) Mesures	876 x 1090 x 2414 mm.	876 x 1090 x 2414 mm.	2000 x 1090 x 2414 mm.	940 x 1180 x 2414 mm.
Temperatura Temperature Température [°C]	0°C/+8°C	-18°C	0°C/+8°C	
Clase Climática Climatic class Classe climatique [°C]	5 / 40°C	4 / 30°C	5 / 40°C	
Tensión/Frecuencia Electrical data Tension électrique	230V/1ph/50Hz			
Controlador Controller Régulateur	Digital IP65			
Material Material [EXT/INT] Matériel	AISI 304			
Espesor Thickness Épaisseur [mm]	80			
Aislamiento Isolation Isolation [mm]	40kg/m ³ / Free CFC's / Zero ODP-GWP			
Capacidad Capacity Capacité [L]	1224	1224	2937	1245
Puertas Doors Portes	1	1	2	1
N° parrillas / Guías N° shelves / Slides N° de grilles / Glissière	-			
Sistema de frío Cooling System Système de froid	MONOBLOCK Ventilado / Forzed Air / Ventilé			
Desescarche Defrost Dégivrage	Parada compresor / Compresor off / Arrêt compresseur.	Gas caliente/ Hot Gas / Gaz Chaude	Parada compresor / Compresor off / Arrêt compresseur.	
Expansión Expansion Expansion	Capilar/ Capillary / Capillaire	Válv. expans. Termostática / Thermostatic expans. valve/ Valv. d'expans. Thermostatique	Capilar/ Capillary / Capillaire	
Potencia Power Puissance [W]	380	870	760	380
Potencia frig. Cooling capacity Puissance Frig. [W A -10°C]	687	1011	1374	687
Consumo Consumption Consommation [kWh/ 24h]	3,90	15,6	7,4	4,86
Clase energética Energy class Classe Énerg.	-			
Refrigerante Refrigerant Gaz	R-290			
Tamaño máximo Carro Size maximum Rack Dimensions max. Chariot	700 x 1880 x 880 mm			
Opcional Optional Options	<p>Manejo control digital bluetooth o wifi/ Operating digital control bluetooth or wifi / Trait. de contrôle digital bluetooth ou wifi</p> <p>Carro / Rack / Chariot (455x635x1787) GN 1/1 [CB6N2011]</p> <p>Carro / Rack / Chariot (660x755x1787) GN2/1 [CB6N2021]</p> <p>Carro / Rack / Chariot (530x705x1787) 600x400 mm [CBE20]</p>			

Serie / Series / Série **RIC**

+Info: www.infrico.com



RIC1PTH
Pasante / Pass-thru / Traversante

Nuevo Controlador digital IP 65.
New Digital control IP65
Contrôleur digital IP 65.



RIC2P



RIC 1P BT

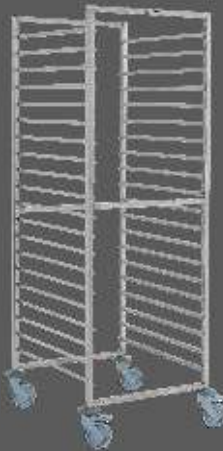

CBGN 2011
CBGN 2021

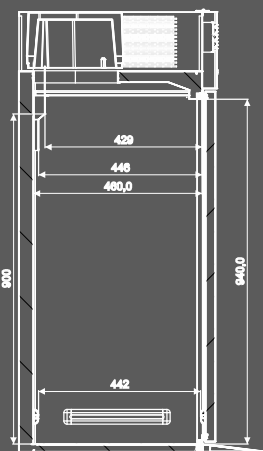

RIC 1P/2P

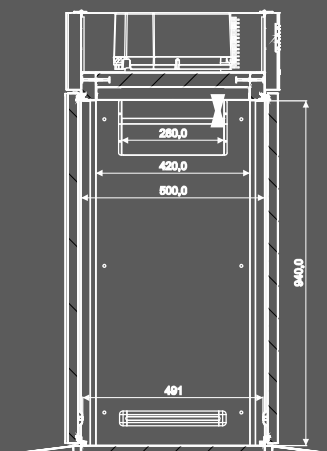

RIC1PTH
Pasante/Pass-thru/Traversante



+Info: www.infrico.com



Abatidores

Blast Chillers / Cellules de Réfrigérissement





Función & Ciclos Work & Cycles Fonction et cycles

142-143

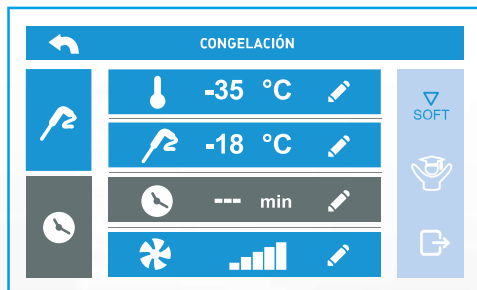

Serie / Series / Série

3, 5, 6, 7, 10, 14 NIVELES / LEVELS / NIVEAUX



ABT 144-145

Serie / Series / Série

20 NIVELES / LEVELS / NIVEAUX



ABT 146-147

Serie / Series / Série

20 DOBLES / DOUBLES / DOUBLES MODULAR / MODULAR / MODULAIRE

Serie / Series / Série



ABT 148-151



4. Abatidores

Blast Chillers / Cellules de Refroidissement

Controlador táctil integrado en la puerta.
Diseño innovador.
USB integrado en el lateral.

Contrôleur tactile intégré dans la porte. Conception innovatrice.
USB intégré sur le côté.

Touch controller integrated in the door.
Innovative design.
USB integrated in the side.



Refrigeración / Refrigeration / Réfrigération



ABT5L



ABT7 1M



ABT10 1L

Compatibles con diferentes tipos de carro.

Compatible with different types of trolleys.

Compatible avec différents types de chariots.

[Rational, Unox, Convothem, etc]



Rampa opcional en los modelos ABT20 [excepto S].

Optional ramp on ABT20 models [except S].

Rampe en option sur les modèles ABT20 [sauf S].



+Info: www.infrico.com

Nuevo tirador en los modelos ABT20.

New handle on ABT20 models.

Nouvelle poignée sur les modèles ABT20.



ABT20 1CBI



ABT20 2P

Nueva cuba recoge aguas en ABT20.

New water collecting tank in ABT20 model.

Nouveau bac de rétention d'eau dans le modèle ABT20.



Función del abatidor y ciclos de trabajo

How blast chillers work & cycle functions

Fonction de la cellule de refroidissement et cycles de travail

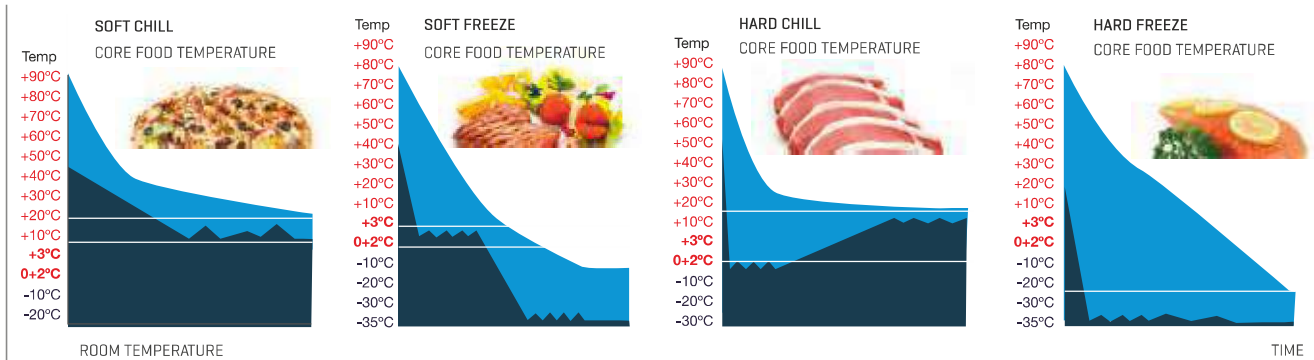
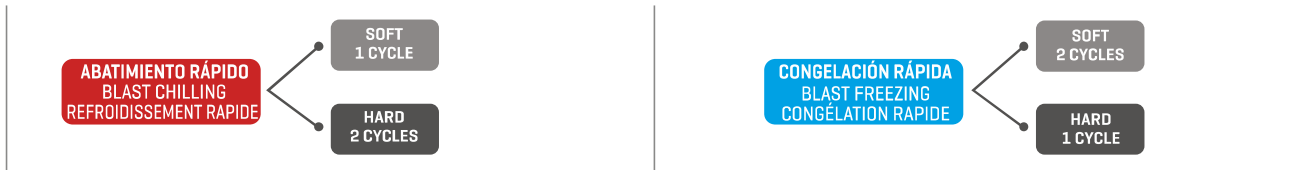

Función de abatidor

Los abatidores permiten reducir en un tiempo muy breve la temperatura en el corazón de los alimentos, sean cocinados o frescos, conservando sus características de frescura, higiene y calidad, disminuyendo los riesgos de proliferación bacteriana.

- La manera tradicional de conservar los alimentos cocinados ha sido dejar enfriar los alimentos al aire libre hasta que la temperatura del alimento alcance una temperatura ideal para su conservación en el refrigerador.

- La fase de enfriamiento entre +65°C y +10°C es un intervalo de tiempo que compromete las características naturales del producto [humedad, consistencia, aroma, color] y lo somete a la agresión y a la consecuente proliferación bacteriana.

- Con los ABATIDORES INFRICO se persigue reducir al máximo la permanencia de los alimentos en este intervalo crítico de temperaturas.

How blast chillers work

Blast chillers quickly reduce the core temperature of the products, whether they are cooked or fresh, conserving their fresh texture, hygiene and quality, whilst reducing the risk of bacteria generation.

- The traditional method of storing cooked food has always been to leave it to cool naturally until it reaches a suitable temperature to store in the refrigerator.

- During the period when the core temperature falls from +65°C and +10°C, the food will lose a lot of its natural characteristics, such as moisture, consistency, aroma and colour. Furthermore, this is when bacteria begin to grow.

- INFRICO BLAST CHILLERS are designed to reduce the time period for this critical change in temperature.

Fonction cellule de ref.

Les cellules de refroidissement permettent de réduire très rapidement la température au cœur des aliments, qu'ils soient cuits ou frais, tout en conservant leurs caractéristiques de fraîcheur, d'hygiène et de qualité, et en réduisant le risque de prolifération bactérienne.

- La manière traditionnelle de conserver les aliments cuisinés est de les laisser refroidir à l'air libre jusqu'à ce que leur température atteigne une valeur idéale pour leur conservation au réfrigérateur.

- La phase de refroidissement de +65°C à +10°C est un espace de temps qui compromet les caractéristiques naturelles du produit [humidité, consistance, arôme et couleur] et l'expose à l'agression ainsi qu'à la prolifération bactérienne qui peut en suivre.

- Les CELLULES DE REFOUILLISSEMENT INFRICO, sont conçues pour réduire au maximum la permanence des aliments dans cet intervalle critique de températures.

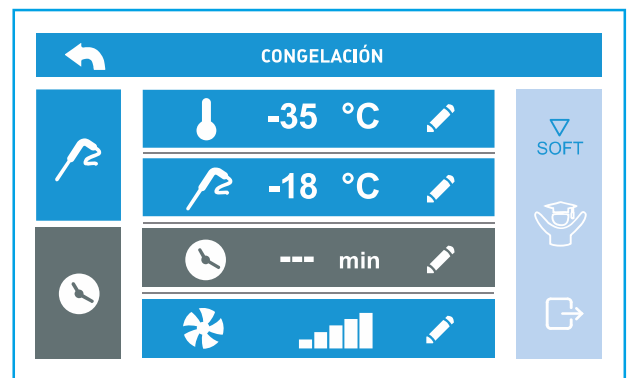

+Info: www.infrico.com

CARACT. PRINCIPALES



Diseño elegante, ausencia de espesor y facilidad de uso.



Opción ciclos personalizados con 3 fases de regulación.



Grado de protección de la interfaz del usuario IP65.



Gestión de ciclos de abatimiento y sobrecongelación, por temperatura y por tiempo, con función "hard/soft" y gestión de la intensidad.



Gestión del test para comprobar que la sonda pincho se ha colocado correctamente (incluidas las sondas de tipo "multipoint").



Representación gráfica en tiempo real del ciclo de abatimiento/sobrecongelación en curso.

MAIN FEATURES

Stylish design, flush mounted, user-friendly.

Option personalized cycles with 3 regulation phases.

User interface with IP65 protection.

Management of blast chilling and freezing cycles, both temperature and time controlled, with hard/soft and intensity management functions.

Runs a test to check that the needle probe is correctly inserted (including multipoint probes).

Real-time graphic display for blast chilling/freezing cycle in progress.

CARACT. PRINCIPALES

Lignes élégantes et faciles d'utilisation.

Option cycles personnalisés avec 3 phases de régulation.

Haute protection de l'interface de l'utilisateur IP65.

Gestion des cycles de refroidissement et de surgélation, par température et durée, avec la fonction « hard/soft » et gestion de l'intensité.

Test pour vérifier si la sonde est correctement mise (inclues les sondes de type « multipoint »).

Représentation graphique en temps réel du cycle de refroidissement et surgélation en cours.



VENTAJAS



Sonda calefactada.



Gestión de ciclos especiales (higienización pescado, descongelación, endurecimiento helado, etc...)



Posibilidad de personalizar 99 programas.

ADVANTAGES

Heated probe.

Management of special cycles (fish sanitation, thawing, ice cream hardening, etc.)

Possibility to personalize 99 programs

AVANTAGES

Sonde chauffée.

Gestion des cycles spéciaux (hygiénisation du poisson, décongélation, durcissement de la glace, etc...)

Possibilité de personnaliser 99 programmes.

Nuevos ciclos especiales como:
Higienización pescado,
descongelación,
endurecimiento helado, etc...

New special cycles:
Fish sanitation, ice cream
hardening, etc...

Nouveaux cycles spéciaux
comme:
hygiénisation du poisson,
décongélation,
durcissement de la glace, etc...



Abatidores y congeladores de temperatura / Blast chillers and freezers / Cellule de refroidissement et surgélation

3 - 5 Niveles / Levels / Niveaux

6 - 7 Niveles / Levels / Niveaux

10 - 14 Niveles / Levels / Niveaux

MODELO
MODELE
MODÈLE



ABT3 1S

ABT5 1L

ABT5 1C

ABT6 1C

ABT7 1L

ABT7 1M

ABT10 1L

ABT14 1L

ABT10 2S

Precio Price Prix									
Medidas Measures (mm) Mesures	721 x 711 x 536 mm.	837 x 870 x 950 mm.	837 x 724 x 800 mm.	508 x 863 x 1059 mm.	837 x 870 x 1120 mm.	1468 x 700 x 940 mm.	837 x 870 x 1730 mm.	837 x 870 x 1730 mm.	1072 x 1076 x 1950 mm.
Temperatura Temperature Température	+3°C / -38°C								
Clase Climática Climatic class Classe climatique	4 / 38°C								
Tensión/Frecuencia Electrical data Tension électrique	220V/1ph/50Hz						380V/3ph/50Hz		
Controlador Controller Régulateur	Táctil / Touch-screen / Tactile IP65								
Material Material (EXT/INT) Matériel	AISI 304								
Espesor Thickness Épaisseur	35	65				65	65	65	
Aislamiento Isolation Isolation	40kg/m ³ / Free CFC's / Zero ODP-GWP								
Capacidad Capacity Capacité	68	125	95	85	160	120	315	315	640
Compresor Compressor Compresseur	1/2	1		1	1 1/4		2	2 1/2	4
Capacidad refrig./cong. Freezing capacity (Kg.) Rendement refroid./cong.	10/5*	20/12*		20/12*	30/18*		40/25*	50/30*	80/50*
Distancia entre bandejas Distance between trays Distance entre bacs	65								80
Nº Bandejas (Opcional) Trays (Optional) Nº Bacs (Option)	3 GN 1/1	5 GN 1/1 600x400	5 GN 1/1	6 GN 1/1	7 GN 1/1 600x400	7 GN 1/1	10 GN 1/1 600x400	14 GN 1/1 600x400	10 GN 2/1 800x600
Sistema de frío Cooling System Système de froid	Forzado / Forced-air / Forcé								
Desescarche Defrost Dégivrage	Parada compresor / Compressor off / Arrêt du compresseur								
Expansión Expansion Expansion	Válvula de expansión termostática / Thermostatic expansion valve / Détendeur thermostatique								
Potencia Power Puissance	761	1205	1412	1125	2409	2393	2250	2824	3517
Potencia frig. Cooling capacity Puissance Frig.	1296	1805			2609		3723	5445	9766
Opcional Optional Options	Esterilizador/Sterilizer/Stérilisateur (407x26) Registrador/Recorder/Enregistreur (308x59) Bandejas inox GN 1/1 / Stainless Steel GN1/1 / Bacs Inox GN 1/1 (501x23)				Bandeja 600x400 / 600x400 trays / Bac 600x400 (A850P41) Manejo control digital bluetooth o wifi / Operating digital control bluetooth or wifi / Trait. de contrôle digital bluetooth ou wifi				
	115V/1ph/60Hz 230V/1ph/60Hz						220V/1ph/50Hz 220V/1ph/60Hz 380V/3ph/60Hz 440V/1ph/60Hz		
	Entrada bandeja / 1S Trays entry / 1C Entrée bac GN 1/1								

*Rendimientos probados según la norma EN17032
*Capacity tested according to EN17032 standard
*Rendement prouvé selon la norme EN17032

Serie / Series / Série **3 - 5 - 6 - 7 - 10 - 14**

+Info: www.infrico.com

ABT7 1M



ABT6 1C



ABT5 1L

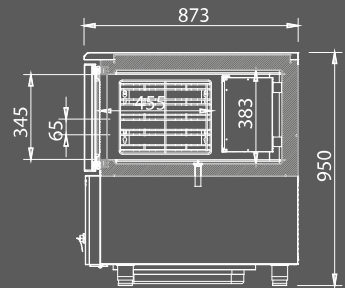

ABT10 1L



ABT10 1L

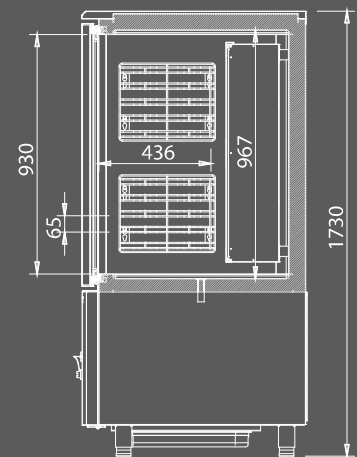

Abatidores y congeladores de temperatura / Blast chillers and freezers / Cellule de refroidissement et surgélation



MODELO
MODELE
MODÈLE

	ABT20 1CBI	ABT20 1C	ABT20 2C	ABT20 1S	ABT20 2S	ABT20 1P	ABT20 2P	ABT20 2CP	ABT20 2SP	ABT20 2PP
Precio Price Prix										
Medidas Measures (mm) Mesures	1200 x 1125 x 2465 mm.	1200 x 1125 x 2280 mm.	1400 x 1325 x 2280 mm.	1200 x 1125 x 2280 mm.	1400 x 1325 x 2280 mm.	1200 x 1120 x 2280 mm.	1400 x 1420 x 2280 mm.	1400 x 1325 x 2280 mm.	1400 x 1325 x 2280 mm.	1400 x 1420 x 2280 mm.
Temperatura Temperature Température	+3°C / -40°C									
Clase Climática Climatic class Classe climatique	4 / 38°C									
Tensión/Frecuencia Electrical data Tension électrique	380V/3ph/50Hz									
Controlador Controller Régulateur	Táctil / Touch-screen / Tactile IP65									
Material Material (EXT/INT) Matériel	AISI 304									
Espesor Thickness Épaisseur	80									
Aislamiento Isolation Isolation	40kg/m ³ / Free CFC's / Zero ODP-GWP									
Capacidad Capacity Capacité	1704	1861	2747	1686	2489	1861	2747	2747	2489	2747
Capacidad refriger./cong. Freezing capacity (Kg.) Rendement refroid./cong.	110 / 60*							230 / 130*		
Tamaño máximo Carro Size maximum Rack Dimensions max. Chariot	700 x 1835 870 mm	700 x 1900 870 mm	830 x 1900 1070 mm	700 x 1700 870 mm	830 x 1700 1070 mm	700 x 1900 870 mm	830 x 1900 1070 mm	830 x 1900 1070 mm	830 x 1700 1070 mm	700 x 1900 1070 mm
Sistema de frío Cooling System Système de froid	Forzado / Forced-air / Forcé									
Desescarche Defrost Dégivrage	Parada compresor / Compressor off / Arrêt du compresseur									
Expansión Expansion Expansion	Válvula de expansión termostática / Thermostatic expansion valve / Détendeur thermostatique									
Potencia Power Puissance	6502	9773	9773	9693		9943		15343	15387	15443
Potencia fríg. Cooling capacity Puissance Frig.	10073 [-10°C] / 5387 [-25°C]							20869 [-10°C] / 11411 [-25°C]		
Opcional Optional Options	Rampa / Ramp / Rampe [RAMABT21] Manejo control digital bluetooth o wifi / Operating digital control bluetooth or wifi / Trait. de contrôle digital bluetooth or wifi					Carro / Rack / Chariot [455x635x1787] 6N 1/1 [CBGN2011] Carro / Rack / Chariot [660x755x1787] 6N2/1 [CBGN2021] Carro / Rack / Chariot [530x705x1787] 600x400 mm [CBE20]				
	-	220V/1ph/50Hz 220V/1ph/60Hz 380V/3ph/60Hz 440V/1ph/60Hz				Opcional Condensadora ventilado axial o ventilado centrifugo o por agua Optional Condensing unit axial ventilated or centrifugal ventilated or water ventilated Options Unité de condensation à ventilation axiale ou centrifuge ou à ventilation par eau				

Motocondensadora incluida
Condensing unit included
Unité de condensation de série

*Rendimientos probados según la norma EN17032
*Capacity tested according to EN17032 standard
*Rendement prouvé selon la norme EN17032

Entrada carro / Car entry / Entrée chariot



Serie / Series / Série **20**

+Info: www.infrico.com

ABT20 1S



ABT20 1CBI



Pantalla táctil de 7"
Tactil 7" screen
Écran tactile de 7"

Abatimiento rápido: +90°C a +3°C en menos de 90 minutos.
Congelación rápida: +90°C a -18°C en menos de 270 minutos.
Blas chilling: +90°C to +3°C in less than 90 minutes.
Blast freezing: +90°C to -18°C in less than 270 minutes.
Refroidissement rapide: +90°C à +3°C en moins de 90 minutes.
Congélation rapide: +90°C à -18°C en moins de 270 minutes.

ABATIMIENTO RÁPIDO
BLAST CHILLING
REFROIDISSEMENT RAPIDE

SOFT
1 CYCLE

HARD
2 CYCLES

CONGELACIÓN RÁPIDA
BLAST FREEZING
CONGÉLATION RAPIDE

SOFT
2 CYCLES

HARD
1 CYCLE

Modelos S compatible con carro Rational
Models S compatible with Rational trolley
Modèles S compatible avec chariot Rational



CBGN 2011
CBGN 2021



ABT20 2P

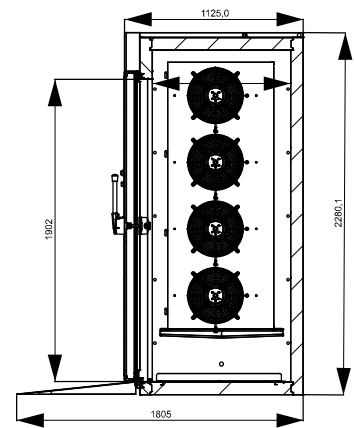

ABT20 1P



Abatidores y congeladores de temperatura / Blast chillers and freezers / Cellule de refroidissement et surgélation



MODELO
MODELE
MODÈLE

MODELO MODELE MODÈLE	ABT20 3C	ABT20 4C	ABT20 3P	ABT20 4P	ABT20 3CP	ABT20 4CP	ABT20 3PP	ABT20 4PP
Precio Price Prix								
Medidas Measures (mm) Mesures	1200 x 2025 x 2280 mm.	1400 x 2425 x 2280 mm.	1200 x 2120 x 2280 mm.	1400 x 2520 x 2280 mm.	1200 x 2025 x 2280 mm.	1400 x 2425 x 2280 mm.	1200 x 2120 x 2280 mm.	1400 x 2520 x 2280 mm.
Temperatura Temperature Température	+3°C / -38°C							
Clase Climática Climatic class Classe climatique	4 / 38°C							
Tensión/Frecuencia Electrical data Tension électrique	380V/3ph/50Hz							
Controlador Controller Régulateur	Táctil / Touch-screen / Tactile IP65							
Material Material (EXT/INT) Matériel	AISI 304							
Espesor Thickness Épaisseur	80							
Aislamiento Isolation Isolation	40kg/m ³ / Free CFC's / Zero ODP-GWP							
Capacidad Capacity Capacité	3633	5388	3633	5388	3633	5388	3633	5388
Capacidad refriger./cong. Freezing capacity (Kg.) Rendement refroid./cong.	200 / 130*				400 / 260*			
Tamaño máximo Carro Size maximum Rack Dimensions max. Chariot	700 x 1900 1770 mm	830 x 1900 2170 mm	700 x 1900 1770 mm	830 x 1900 2170 mm	700 x 1900 1770 mm	830 x 1900 2170 mm	700 x 1900 1770 mm	830 x 1900 2170 mm
Sistema de frío Cooling System Système de froid	Forzado / Forced-air / Forcé							
Desescarche Defrost Dégivrage	Parada compresor / Compressor off / Arrêt du compresseur							
Expansión Expansion Expansion	Válvula de expansión termostática / Thermostatic expansion valve / Détendeur thermostatique							
Potencia Power Puissance	19546				30886			
Potencia frig. Cooling capacity Puissance Frig.	20146 [-10°C] / 11411 [-25°C]				41738 [-10°C] / 22822 [-25°C]			
Opcional Optional Options	Rampa / Ramp / Rampe [RAMABT21] Manejo control digital bluetooth o wifi / Operating digital control bluetooth or wifi / Trait. de contrôle digital bluetooth ou wifi				Carro / Rack / Chariot [660x755x1787] 6N2/1 [CBGN2021] Carro / Rack / Chariot [530x705x1787] 600x400 mm [CBE20]			
	220V/1ph/50Hz 220V/1ph/60Hz 380V/3ph/60Hz 440V/1ph/60Hz				Opcional Condensadora ventilado axial o ventilado centrífugo o por agua Optional Condensing unit axial ventilated or centrifugal ventilated or water ventilated Options Unité de condensation à ventilation axiale ou centrifuge ou à ventilation par eau			

Motocondensadora incluida
Condensing unit included
Unité de condensation de série

***Rendimientos probados según la norma EN17032**
*Capacity tested according to EN17032 standard
*Rendement prouvé selon la norme EN17032

Entrada carro / Car entry / Entrée chariot
3C / 4C
Ruedas dentro
Casters inside
Roulettes à l'intérieur

3CP / 3PP / 4CP / 4PP
Potenciados
Powerfull
Pleine puissance

3P / 4P
Pasante
Pass-throw
Traversante

Serie / Series / Série 20 (Doble / Double / Double)

+Info: www.infrico.com



Pantalla táctil de 7"
Tactil 7" screen
Écran tactile de 7"



ABT20 4PP



Abatimiento rápido: +90°C a +3°C en menos de 90 minutos.
Congelación rápida: +90°C a -18°C en menos de 270 minutos.

Blast chilling: +90°C to +3°C in less than 90 minutes.
Blast freezing: +90°C to -18°C in less than 270 minutes.

Refroidissement rapide: +90°C à +3°C en moins de 90 minutes.
Congélation rapide: +90°C à -18°C en moins de 270 minutes.

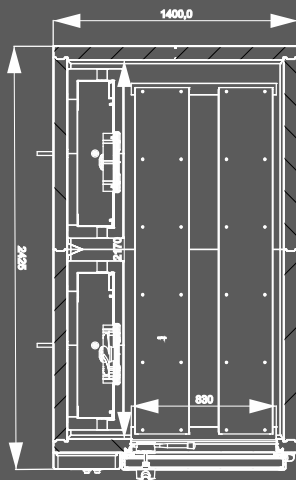

Planta / Floor plan / Plan d'étage

ABT20 4P

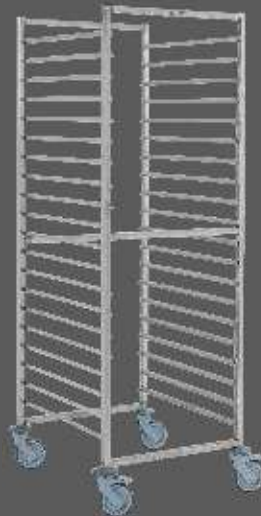

CBGN 2021 / CBGN 2011

Motocondensadora incluida
Condensing unit included
Unité de condensation de série



Abatidores tunel modular / Modular Blast chillers / Modulaires Cellule de refroidissement et surgélation

Abatidores Modulares

- Panel acero inox AISI 304 multiplicando por 2, 3, 4, etc, el número de carros de producto.
- Configuración de puertas pasantes en los extremos, y efecto túnel en el interior.
- Disponibles con unidades potenciadas a medida, o motocondensadoras por agua.
- Consultar proyectos a medida.

Modular Blast Chillers

- AISI 304 stainless steel panel increasing by 2, 3, 4, etc., the number of product trolleys.
- Configuration of through doors at the entry and exit, and tunnel effect inside.
- Available with customised powered units or water condensing units.
- Consult customised projects

Cellules de refroidissement modulaires

- Panneau en acier inoxydable AISI 304 multipliant par 2, 3, 4, etc, le nombre de chariots de produits.
- Configuration de portes traversantes à l'entrée et à la sortie, et effet tunnel à l'intérieur.
- Disponible avec des unités motorisées personnalisées ou des unités de condensation à eau.
- Consulter les projets personnalisés

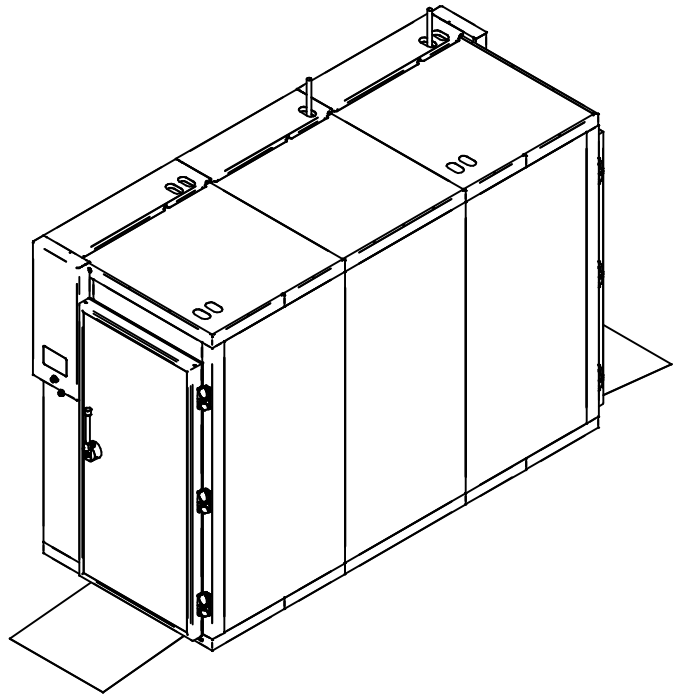

+Info: www.infrico.com



i-line

5





Infrico
4.5

Questo frigorifero è stato studiato e progettato per ospitare una grande varietà di alimenti e bevande. È dotato di una grande capacità di stoccaggio e di una grande versatilità. È adatto per uso commerciale e domestico. È dotato di una grande capacità di stoccaggio e di una grande versatilità. È adatto per uso commerciale e domestico.

Questo frigorifero è stato studiato e progettato per ospitare una grande varietà di alimenti e bevande. È dotato di una grande capacità di stoccaggio e di una grande versatilità. È adatto per uso commerciale e domestico. È dotato di una grande capacità di stoccaggio e di una grande versatilità. È adatto per uso commerciale e domestico.

Infrico
1.4NS

Serie / Series / Série

IABT



IABT3 1S
IABT5 1L
IABT10 1L 158-159

Serie / Series / Série

IEB



IEB 160-161

Serie / Series / Série

IM600



IM P
IM PN
IM PCR 162-163

Serie / Series / Série

IM700



IM P
IM PN
IM PCR 164-165

Serie / Series / Série

IF600



IF P
IF PCR 166-167

Serie / Series / Série

IMC / IEST



IMC
IEST 168-169

Serie / Series / Série

IAN 500/1000L



IAN
IAN N
IAN CR 170-171

Serie / Series / Série

IAG 700/1400L



IAG
IAG N
IAG CR 172-173



5. i-Line

Refrigeración / Refrigeration / Réfrigération

Sistemas de frío ventilado. Bandejas evaporativas sin resistencia eléctrica para una mayor eficiencia energética. Sistemas de evaporación forzada. Evaporadores tratados con Epoxi de poliéster anticorrosión. Unidades sobredimensionadas y eficientes. Válvulas de expansión termostáticas y desescarches por gas caliente en baja temperatura. Marcos de puerta calefactados para evitar acumulación de hielo.

Forced air cooling systems. Energy-saving non-electric condensate pans. Forced evaporation systems. Evaporators treated with anti-corrosion polyester Epoxy. Oversized and efficient units. Expansion valves. Hot gas defrost. Heating door frames to prevent ice build-up.

Systèmes de froid ventilé. Bacs d'évaporation sans résistances électriques pour une meilleure efficacité énergétique. Systèmes d'évaporation forcé. Évaporateurs traités avec un époxy polyester anticorrosion. Unités efficaces et surdimensionnées. Valves d'expansion thermostatiques. Dégivrage par gaz chaud. Cadres de portes chauffés pour empêcher l'accumulation de glace.

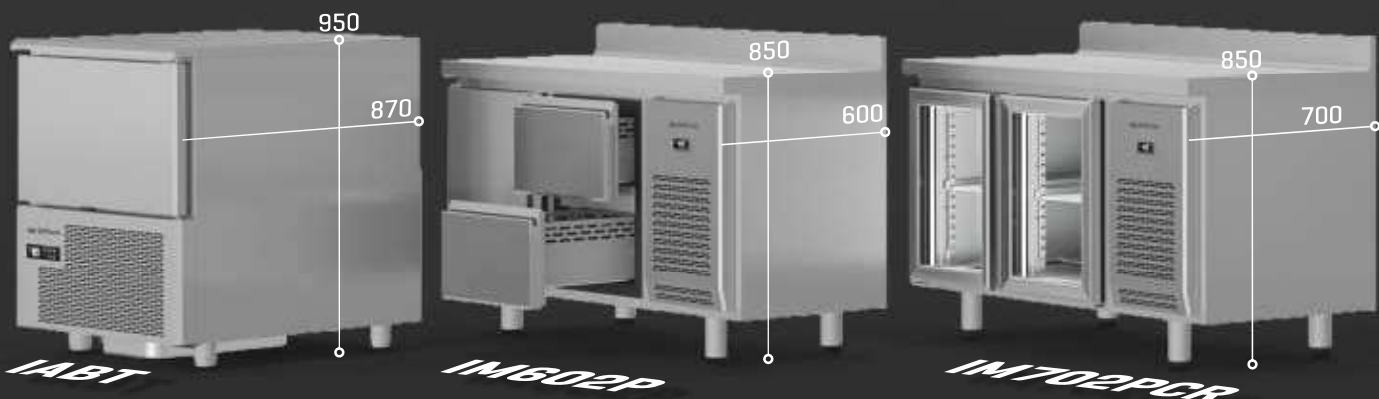

Cajones con guías telescópicas.

Drawers with telescopic guides.

Tiroirs avec glissières télescopiques.



Encimera reforzada con Omegas de serie [series 600/700].

Reinforced worktop with Omegas as standard [600/700 series].

Plan de travail renforcé avec Omegas en standard [séries 600/700].



+Info: www.infrico.com

Soporte de cremallera para guías.

Rack and pinion support for guides.

Support de crémaillère pour guides.



**Nuevo tirador en puertas de cristal /
New handle for glass doors /
Nouvelle poignée sur les portes en verre**

Tirador de aluminio ergonómico completo,
integrado en el marco de puerta de cristal.

Ergonomic aluminium handle, fully integrated in
the glass door frame.

Poignée ergonomique en aluminium,
entièrement intégrée dans le cadre de la porte
en verre.



Puertas con tirador
embutido y burlete plano
desmontable "cleanless".

Inlay doors handle and flat
gasket easily removable
"cleanless".

Poignée de porte encastrée
et joint plat facilement
démontable "cleanless".



Abatidores y congeladores de temperatura 3, 5 y 10 niveles / Blast chillers and freezers 3, 5 & 10 levels / Cellule de refroidissement et surgélation 3, 5 et 10 niveaux

MODELO
MODELE
MODÈLE



IABT3 1S



IABT5 1L



IABT10 1L

Precio Price Prix			
Medidas Measures (mm) Mesures	↔ ↗ ↕	721 x 711 x 536 mm.	837 x 870 x 950 mm.
Temperatura Temperature Température	[°C]	+3°C / -38°C	
Clase Climática Climatic class Classe climatique	[°C]	4 / 38°C	
Tensión/Frecuencia Electrical data Tension électrique		220V/2ph/50Hz	380V/3ph/50Hz
Controlador Controller Régulateur		Tácti / Touch-screen / Tactile IP65	
Material Material (EXT/INT) Matériel		AISI 430	
Espesor Thickness Épaisseur	[mm]	35	65
Aislamiento Isolation Isolation	[mm]	40kg/m ³ / Free CFC's / Zero ODP-GWP	
Capacidad Capacity Capacité	[L]	68	125
Compresor Compressor Compresseur	[HP]	1/2	1
Blast chilling Freezing capacity [Kg.] Rendement refroid./cong.		10/5*	20/12*
Distancia entre bandejas Distance between trays Distance entre bacs		65	
Nº Bandejas (Opcional) Trays (Optional) Nº Bacs (Option)		3 GN 1/1	5 GN 1/1 600x400
Sistema de frío Cooling System Système de froid		Forzado / Forced-air / Forcé	
Desescarche Defrost Dégivrage		Parada compresor / Compressor off / Arrêt du compresseur	
Expansión Expansion Expansion		Válvula de expansión termostática / Thermostatic expansion valve / Détendeur thermostatique	
Potencia Power Puissance	[W]	761	1205
Potencia frig. Cooling capacity Puissance Frig.	[W A -10°C]	1296	1805
Opcional Optional Options		Esterilizador/Sterilizer/Stérilisateur (407x26) Registador/Recorder/Enregistreur (308x59) Bandejas inox GN 1/1 / Stainless Steel GN1/1 / Bacs Inox GN 1/1 (501x23) Bandeja 600x400 / 600x400 trays / Bac 600x400 (A850P41)	

Entrada bandeja / 1S 1L
Trays entry / 1C GN 1/1
Entrée bac GN 1/1 600x400

*Rendimientos probados según la norma EN17032
*Capacity tested according to EN17032 standard
*Rendement prouvé selon norme EN17032

Serie / Series / Série **IABT**

+Info: www.infrico.com

IABT10 1L

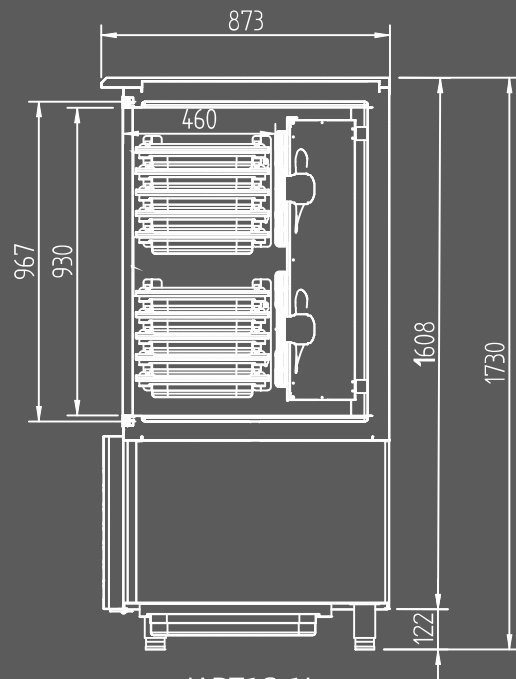

IABT10 1L

IABT5 1L

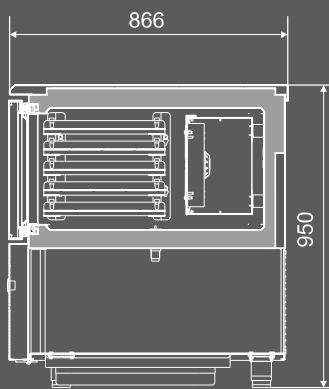

IABT5 1L



Refrigerador de botellas / Chest bottle cooler / Refrigerateur de bouteilles

MODELO
MODELE
MODÈLE



IEB 100



IEB 150



IEB 200

MODELO MODELE MODÈLE	IEB 100	IEB 150	IEB 200
Precio Price Prix			
Medidas Measures (mm) Mesures	1004 x 550 x 865 mm.	1479 x 550 x 865 mm.	1954 x 550 x 865 mm.
Temperatura Temperature Température	+3°C/+6°C		
Clase Climática Climatic class Classe climatique	4 / 38°C		
Tensión/Frecuencia Electrical data Tension électrique	230V/1ph/50Hz		
Controlador Controller Régulateur	-		
Material Material (EXT/INT) Matériel	AISI 430		
Espesor Thickness Épaisseur	40		
Aislamiento Isolation Isolation	40kg/m ³ / Free CFC's / Zero ODP-GWP		
Capacidad Capacity Capacité	265	445	620
Puertas Doors Portes	2	3	4
N° parrillas / Guías N° shelves / Slides N° de grilles / Glissière	-		
Sistema de frío Cooling System Système de froid	Forzado / Forced air / Ventilé		
Desescarche Defrost Dégivrage	-		
Expansión Expansion Expansion	Capilar / Capillary / Capillaire		
Potencia Power Puissance	122	180	
Potencia frig. Cooling capacity Puissance Frig.	169	370	
Consumo Consumption Consommation	-		
Clase energética Energy class Classe Énerg.	-		
Refrigerante Refrigerant Gaz	R-600a	R-290	
Opcional Optional Options	-		

Serie / Series / Série **IEB**

+Info: www.infrico.com



Mesas refrigeración, congelación y puertas de cristal / Refrigerated counters, freezers and glass doors / Dessertes positives et négatives

MODELO MODELE MODÈLE



Precio Price Prix										
Medidas Measures (mm) Mesures	1468 x 600 x 850 mm.	1960 x 600 x 850 mm.	2452 x 600 x 850 mm.	1468 x 600 x 850 mm.	1960 x 600 x 850 mm.	2452 x 600 x 850 mm.	1468 x 600 x 850 mm.	1960 x 600 x 850 mm.	2452 x 600 x 850 mm.	
Temperatura Temperature Température	-2°C/+8°C			-18°C			+2°C/+6°C			
Clase Climática Climatic class Classe climatique	4 / 38°C									
Tensión/Frecuencia Electrical data Tension électrique	230V/1ph/50Hz									
Controlador Controller Régulateur	Táctil Digital IP65									
Material Material (EXT/INT) Matériel	AISI 430 / Encimera-Worktop-Dessus AISI 304									
Espesor Thickness Épaisseur	70									
Aislamiento Isolation Isolation	40kg/m ³ / Free CFC's / Zero ODP-GWP									
Capacidad Capacity Capacité	255	400	540	255	400	540	255	400	540	
Puertas Doors Portes	2	3	4	2	3	4	2	3	4	
Nº estantes Nº shelves Nº d'étagères	2	3	4	2	3	4	2	3	4	
Sistema de frío Cooling System Système de froid	MONOBLOCK Forzado / Forced air / Ventilé									
Desescarche Defrost Dégivrage	Parada compresor / Compressor off / Arrêt du compresseur			Gas caliente / Hot gas / Gaz chaud			Parada compresor / Compressor off / Arrêt du compresseur			
Expansión Expansion Expansion	Capilar / Capillary / Capillaire			Válvula de expansión termostática / Thermostatic expansion valve / Valve d'expansion thermostatique			Capilar / Capillary / Capillaire			
Potencia Power Puissance	255	410	605	694	723	264	269	429		
Potencia frig. Cooling capacity Puissance Frig.	370	690	445	540	370	690				
Consumo Consumption Consommation	2,04	2,37	2,40	4,02	6,57	6,78	-			
Clase energética Energy class Classe Énerg.	B			C			-			
Refrigerante Refrigerant Gaz	R-290									
Opcional Optional Options	Parrilla / Wire shelf / Grille [502X07]						39 €			
	115V/1ph/60Hz 230V/1ph/60Hz			115V/1ph/60Hz 230V/1ph/60Hz			115V/1ph/60Hz 230V/1ph/60Hz			
	Kit 2 cajones / 2 Drawer Kit / Kit 2 tiroirs 1/2 x 200 [JCAJ17FM61/2]						-			

Serie / Series / Série **IM 600**

+Info: www.infrico.com

IM602PCR



Opcional Kit 2 cajones /
Optional 2 Drawer Kit /
Optional Kit 2 tiroirs
1/2 x 200 (JCAJ17FM61/2)

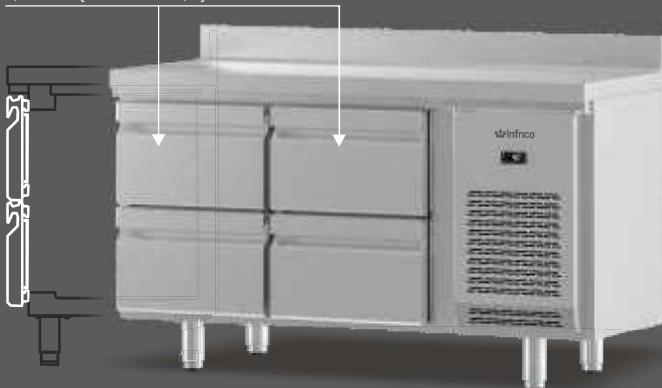

IM602P

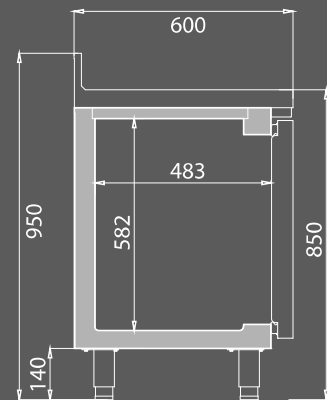

Controlador digital IP 65.
Digital control IP65
Contrôleur digital IP 65.











Circulación optimizada del aire
Optimal air flow
Circulation d'air optimisée

Sistema de ventilación de condensación frontal
Front breathing condensation system
Système de ventilation à condensation frontale

Tirador p. cristal
Glass door handle
Poignée p. vitrée



Mesas refrigeración, congelación y puertas de cristal GN1/1 / GN1/1 Refrigerated counters, freezers and glass doors / Dessertes positives, négatives et portes vitrées GN1/1

MODELO MODELE MODÈLE										
Precio Price Prix										
Medidas Measures (mm) Mesures	1468 x 700 x 850 mm.	1960 x 700 x 850 mm.	2452 x 700 x 850 mm.	1468 x 700 x 850 mm.	1960 x 700 x 850 mm.	2452 x 700 x 850 mm.	1468 x 700 x 850 mm.	1960 x 700 x 850 mm.	2452 x 700 x 850 mm.	
Temperatura Temperature Température	-2°C/+8°C			-18°C			+2°C/+6°C			
Clase Climática Climatic class Classe climatique	4 / 38°C									
Tensión/Frecuencia Electrical data Tension électrique	230V/1ph/50Hz									
Controlador Controller Régulateur	Digital IP65									
Material Material (EXT/INT) Matériel	AISI 430 / Encimera-Worktop-Dessus AISI 304									
Espesor Thickness Épaisseur	70									
Aislamiento Isolation Isolation	40kg/m ³ / Free CFC's / Zero ODP-GWP									
Capacidad Capacity Capacité	305	465	630	305	465	630	305	465	630	
Puertas Doors Portes	2	3	4	2	3	4	2	3	4	
Nº estantes Nº shelves Nº d'étagères	2	3	4	2	3	4	2	3	4	
Sistema de frío Cooling System Système de froid	MONOBLOCK Forzado / Forced air / Ventilé									
Desescarche Defrost Dégivrage	Parada compresor / Compressor off / Arrêt du compresseur			Gas caliente / Hot gas / Gaz chaud			Parada compresor / Compressor off / Arrêt du compresseur			
Expansión Expansion Expansion	Capilar / Capillary / Capillaire			Válvula de expansión termostática / Thermostatic expansion valve / Valve d'expansion thermostatique			Capilar / Capillary / Capillaire			
Potencia Power Puissance	297	460	645	735	880	300	474	479		
Potencia fríg. Cooling capacity Puissance Frig.	370	690	445	540	640	370	690			
Consumo Consumption Consommation	1,97	2,26	2,61	5,54	7,79	9,03	-			
Clase energética Energy class Classe Énerg.	B			C			D			-
Refrigerante Refrigerant Gaz	R-290									
Opcional Optional Options	Parrilla / Wire shelf / Grille 530x325 [502X12] Juego de guías / Slides / Jeu de glissières [GUAL0115550; GUAL0215550]									
	115V/1ph/60Hz 230V/1ph/60Hz			115V/1ph/60Hz 230V/1ph/60Hz			115V/1ph/60Hz 230V/1ph/60Hz			
	Kit 2 cajones / 2 Drawer Kit / Kit 2 tiroirs 1/2 x 200 [JCAJ17FM71/2]						-			

Serie / Series / Série **IM 700**

+Info: www.infrico.com

IM703PN



Ventilación frontal
Front breathing
Ventilation frontale



Controlador digital IP 65.
Digital control IP65
Contrôleur digital IP 65.



Circulación optimizada del aire
Optimal air flow
Circulation d'air optimisée

Sistema de ventilación de condensación frontal
Front breathing condensation system
Système de ventilation à condensation frontale

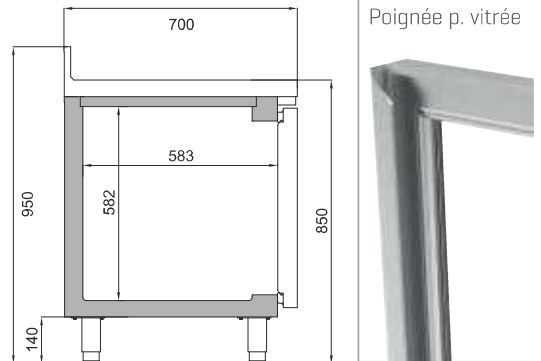

Tirador p. cristal
Glass door handle
Poignée p. vitrée



Opcional Kit 2 cajones /
Optional 2 Drawer Kit /
Optional Kit 2 tiroirs



IM702P

Costado inyectado
Insulated side
Joue Isolée

Puertas con doble acristalamiento [6-15-5]
Double glazed doors [6-15-5]
Portes double vitrage [6-15-5]



IM702PCR

Frente mostrador / Tall back bar counter / Dessertes arrière bar positives

MODELO
MODELE
MODÈLE



IF602P



IF603P



IF604P



IF602PCR



IF603PCR



IF604PCR

Precio Price Prix										
Medidas Measures (mm) Mesures	↔	↗	↘	↕	1468 x 600 x 1050 mm.	1960 x 600 x 1050 mm.	2452 x 600 x 1050 mm.	1468 x 600 x 1050 mm.	1960 x 600 x 1050 mm.	2452 x 600 x 1050 mm.
Temperatura Temperature Température	[°C]	-2°C/+8°C				+2°C/+6°C				
Clase Climática Climatic class Classe climatique	[°C]	4 / 38°C								
Tensión/Frecuencia Electrical data Tension électrique		230V/1ph/50Hz								
Controlador Controller Régulateur		Digital IP65								
Material Material (EXT/INT) Matériel		AISI 430 / Encimera-Worktop-Dessus AISI 304								
Espesor Thickness Épaisseur	[mm]	70								
Aislamiento Isolation Isolation	[mm]	40kg/m ³ / Free CFC's / Zero ODP-GWP								
Capacidad Capacity Capacité	[L]	345	535	730	345	535	730			
Puertas Doors Portes		2	3	4	2	3	4			
Nº estantes Nº shelves Nº d'étagères		4	6	8	4	6	8			
Sistema de frío Cooling System Système de froid		MONOBLOCK Forzado / Forced air / Ventilé								
Desescarche Defrost Dégivrage		Parada compresor / Compressor off / Arrêt du compresseur								
Expansión Expansion Expansion		Capilar / Capillary / Capillaire								
Potencia Power Puissance	[W]	264	435		273	450	455			
Potencia fríg. Cooling capacity Puissance Frig.	[W A -10°C]	370	690		370	690	690			
Consumo Consumption Consommation	[kWh/ 24h]	2,04	2,40	2,73	-	-	-			
Clase energética Energy class Classe Énerg.		B								
Refrigerante Refrigerant Gaz		R-290								
Opcional Optional Options		Parrilla / Wire shelf / Grille 325x430 [502X07] 115V/1ph/60Hz 230V/1ph/60Hz								
		Tolva / Coffee-grounds hopper / Tiroir marc à café ou 1 tiroir neutre								



Serie / Series / Série **IF 600**

+Info: www.infrico.com

IF603P



Suplemento Parrilla incluido
Supplement Wire Shelf including
 Supplément Grille inclus

Puertas con doble acristalamiento (6-15-5)
 Double glazed doors (6-15-5)
 Portes double vitrage (6-15-5)

Controlador digital IP 65.
 Digital control IP65
 Contrôleur digital IP 65.



Tolva opcional
 Optional coffee-grounds hopper
 Tiroir marc à café ou 1 tiroir neutre



Tirador p. cristal
 Glass door handle
 Poignée p. vitrée

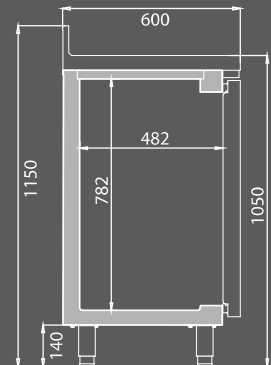
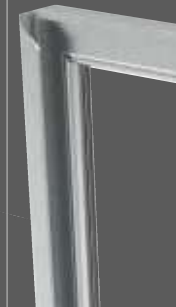







IF603PCR

**Mesas cafetera /
Shelf unit /
Meuble étagère
(IEST)**

MESA CAFETERA / COFFE UNIT / MEUBLE CAFÉTÉRIA

**Mesas estantería /
Coffee unit /
Meuble cafétéria
(IMC)**

MESA ESTANTERÍA / SHELF UNIT / MEUBLE ÉTAGÈRE

MODELO MODELE MODÈLE						
Precio Price Prix						
Medidas Measures (mm) Mesures	1000 x 600 x 1050 mm.	1470 x 600 x 1050 mm.	1960 x 600 x 1050 mm.	1000 x 600 x 1050 mm.	1470 x 600 x 1050 mm.	1960 x 600 x 1050 mm.
Material Material Matériel	[EXT/INT] AISI 304					
Puertas Doors Portes	1	1	1	-	-	-
Cajones / Tolva Drawers / Hopper Portes	1/1	1/1	2/1	-	-	-
Estantes Shelves Étagères	1	1	1	1	1	1
Opcional Optional Options	Estante adicional / Additional shelf / Étagère extra (IMC100) 90 € Estante adicional / Additional shelf / Étagère extra (IMC150) 107 € Estante adicional / Additional shelf / Étagère extra (IMC200) 123 €			Estante adicional / Additional shelf / Étagère extra (IEST100) 37 € Estante adicional / Additional shelf / Étagère extra (IEST150) 54 € Estante adicional / Additional shelf / Étagère extra (IEST200) 90 €		



IMC150



IEST150

Serie / Series / Série **IMC / IEST**

+Info: www.infrico.com

IMC200



IMC100

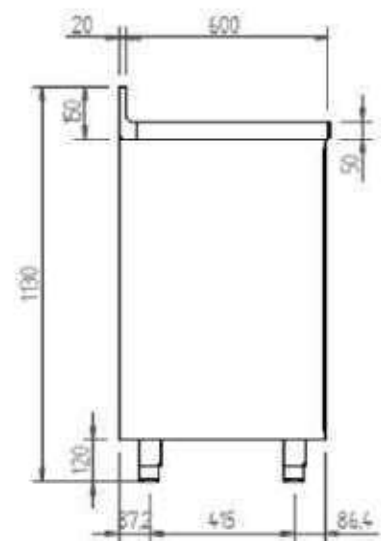

Armario refrigeración, congelación y puertas de cristal / Reach in refrigerators, freezers and glass door / Armoires positives, négatives et portes vitrées

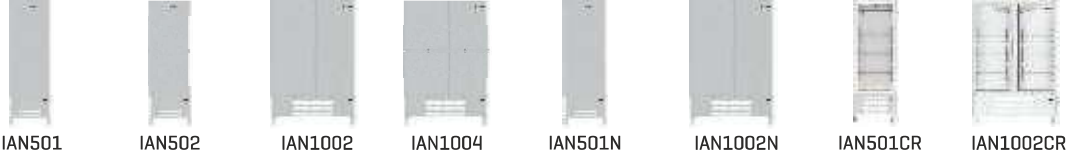

MODELO MODELE MODÈLE	IAN501	IAN502	IAN1002	IAN1004	IAN501N	IAN1002N	IAN501CR	IAN1002CR
Precio Price Prix								
Medidas Measures (mm) Mesures	687 x 712 x 2060 mm.	687 x 712 x 2060 mm.	1385 x 712 x 2060 mm.	1385 x 712 x 2060 mm.	687 x 712 x 2060 mm.	1385 x 712 x 2060 mm.	687 x 712 x 2060 mm.	1387 x 712 x 2060 mm.
Temperatura Temperature Température	-2°C/+8°C				-18°C		+2°C/+6°C	
Clase Climática Climatic class Classe climatique	4 / 38°C							
Tensión/Frecuencia Electrical data Tension électrique	230V/1ph/50Hz							
Controlador Controller Régulateur	Digital IP65							
Material Material (EXT/INT) Matériel	AISI 430							
Espesor Thickness Épaisseur	55							
Aislamiento Isolation Isolation	40kg/m ³ / Free CFC's / Zero ODP-GWP							
Capacidad Capacity Capacité	490		1070		490	1070	490	1070
Puertas Doors Portes	1	2	2	4	1	2	1	2
Nº estantes Nº shelves Nº d'étagères	3		6		3	6	3	6
Sistema de frío Cooling System Système de froid	Forzado / Forced air / Ventilé							
Desescarche Defrost Dégivrage	Parada compresor / Compressor off / Arrêt du compresseur				Gas caliente / Hot gas / Gaz chaud		Parada compresor / Compressor off / Arrêt du compresseur	
Expansión Expansion Expansion	Capilar / Capillary / Capillaire							
Potencia Power Puissance	265		435		625	905	285	475
Potencia frig. Cooling capacity Puissance Frig.	370		690		540	720	370	690
Consumo Consumption Consommation	1,58		3,04		6,70	11,85	-	-
Clase energética Energy class Classe Énerg.	C				D		-	
Refrigerante Refrigerant Gaz	R-290							
Opcional Optional Options	Parrilla / Wire shelf / Grille [502X14] Ruedas / Casters / Roulettes [705X16=2; 705X17=2] 115V/1ph/60Hz 230V/1ph/60Hz							

Serie / Series / Série **IAN 500/1000**

+Info: www.infrico.com

IAN1002 CR

Puerta con doble acristalamiento [6-15-5]
Double glazed door [6-15-5]
Portes double vitrage [6-15-5]

3 parrillas por puerta
3 shelves per door
3 grilles par porte

Tirador p. cristal
Glass door handle
Poignée p. vitrée



IAN501



IAN1002N

Controlador digital IP 65.
Digital control IP65
Contrôleur digital IP 65.

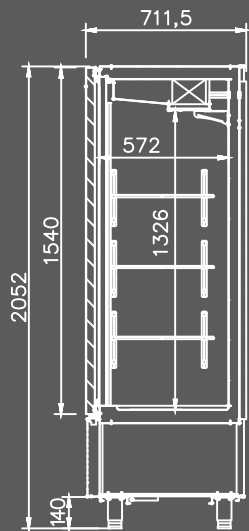

Armario refrigeración, congelación y puertas de cristal / Reach in refrigerators, freezers and glass door / Armoires positives, négatives et portes vitrées

REFRIG / REFRIG / POSIT

CONGEL / FREEZ / NÉGAT

REFRIG / REFRIG / POSIT



MODELO
MODELE
MODÈLE

IAG701

IAG1402

IAG701N

IAG1402N

IAG701CR

IAG1402CR

Precio Price Prix						
Medidas Measures (mm) Mesures	687 x 838 x 2060 mm.	1387 x 838 x 2060 mm.	687 x 838 x 2060 mm.	1387 x 838 x 2060 mm.	687 x 838 x 2060 mm.	1387 x 838 x 2060 mm.
Temperatura Temperature Température	-2°C/+8°C		-18°C		+2°C/+6°C	
Clase Climática Climatic class Classe climatique	4 / 38°C					
Tensión/Frecuencia Electrical data Tension électrique	230V/1ph/50Hz					
Controlador Controller Régulateur	Digital IP65					
Material Material (EXT/INT) Matériel	AISI 430					
Espesor Thickness Épaisseur	55					
Aislamiento Isolation Isolation	40kg/m ³ / Free CFC's / Zero ODP-GWP					
Capacidad Capacity Capacité	580	1280	580	1280	580	1280
Puertas Doors Portes	1	2	1	2	1	2
Nº estantes Nº shelves Nº d'étagères	3	6	3	6	3	6
Sistema de frío Cooling System Système de froid	Forzado / Forced air / Ventilé					
Desescarche Defrost Dégivrage	Parada compresor / Compressor off / Arrêt du compresseur		Gas caliente / Hot gas / Gaz chaud		Parada compresor / Compressor off / Arrêt du compresseur	
Expansión Expansion Expansion	Capilar / Capillary / Capillaire		Válvula de expansión termostática / Thermostatic expansion valve / Valve d'expansion thermostatique		Capilar / Capillary / Capillaire	
Potencia Power Puissance	265	445	625	905	285	495
Potencia frig. Cooling capacity Puissance Frig.	370	690	540	720	370	690
Consumo Consumption Consommation	2,5	3,3	8,45	15,21	-	
Clase energética Energy class Classe Énerg.	D	C	C	D	-	
Refrigerante Refrigerant Gaz	R-290					
Opcional Optional Options	Parrilla / Wire shelf / Grille (530X650mm) (502X14) Juego de guías GD / Slides GD / Jeu de Glisières GD (GUIAL0115641; GUIAL0215641) Ruedas / Casters / Roulettes (705X16=2; 705X17=2) Juego de guías / Slides / Jeu de Glisières GN 2/1 650x450 (GUIA01UAGB/GUIA02UAGB) Juego de guías / Slides / Jeu de Glisières 600x400 (GUIAL01641P/GUIAL02641P) 115V/1ph/60Hz 230V/1ph/60Hz					

Serie / Series / Série **IAG 700/1400**

+Info: www.infrico.com

IAG701

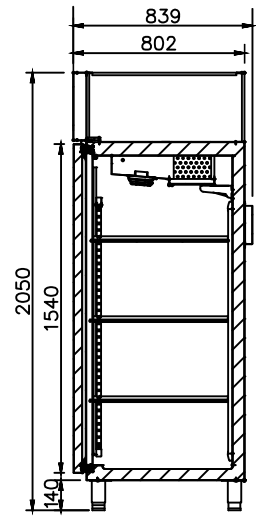

Controlador digital IP 65.
Digital control IP65
Contrôleur digital IP 65.



IAG1402CR

Puerta con doble acristalamiento (6-15-5)
Double glazed door (6-15-5)
Portes double vitrage (6-15-5)

OPCIONAL
OPTIONAL
OPTIONAL



Tirador p. cristal
Glass door handle
Poignée p. vitrée

