

# Enfriadores

Boottle Cooler / Refroidisseur de bouteilles





Serie / Series / Série

## EFP



EFP EG  
EFP II \_\_\_\_\_ 32-33

Serie / Series / Série

## EBC



EB II \_\_\_\_\_ 34-35

Serie / Series / Série

## ERV (850/920)



ERV SH  
ERV II SH  
ERV PP  
ERV  
ERV C \_\_\_\_\_ 36-39

Serie / Series / Série

## ERV inox



ERV II  
ERV PP II \_\_\_\_\_ 40-41

Serie / Series / Série

## ERV / ERC



ERV  
ERC  
ERC B \_\_\_\_\_ 42-43

Serie / Series / Série

## MINIMARKET



ERC PH  
ERC PH BT \_\_\_\_\_ 44-45

Serie / Series / Série

## NEC



NEC RV  
NEC FS  
NEC FV \_\_\_\_\_ 46-47

Serie / Series / Série

## SUPERCOOLER



SPC  
SPC B \_\_\_\_\_ 48-49

Serie / Series / Série

## ESC / TA



ESC  
ESC CR  
TA II \_\_\_\_\_ 50-51



# 1. Enfriadores

## Bottle coolers / Refroidisseurs de bouteilles

### Iluminación / Lighting / Éclairage

Incorporación de iluminación LED, llegando a reducir el consumo energético entre un 80% y 90%, respecto a una bombilla tradicional. RGB opcional.

LED lighting incorporated, reducing energetic consumption between 80% and 90% respect to a traditional light bulb. RGB optional.

Éclairage LED, réduisant la consommation énergétique entre 80% et 90%, par rapport à une ampoule traditionnelle. RGB optionnel.



Cabezal iluminado opcional.

Option Canopy.

Canopy en option.



**EFPEG**



**ERV**

Doble acristalamiento templado, bajo emisor con carga de Argón [4-27-4].

Double tempered glass, low-e with argon charge [4-27-4].

Triple vitrage et verre trempé [4-12-3-12-4].



Nuevo Co  
intuitivo I

New Digi  
intuitive-

Nouveau  
intuitif IP

+Info: [www.infrieco.com](http://www.infrieco.com)



Controlador digital táctil e IP 65.

Digital control easy and touch screen IP65 protection.

Contrôleur digital tactile e IP 65.



Nuevo Controlador digital táctil e intuitivo IP 65.

New Digital control easy and intuitive-touch screen IP65 protection.

Nouveau Contrôleur digital tactile e intuitif IP 65.



# Refrigerador de botellas / Chest bottle cooler / Refroidisseur de bouteilles



MODELO MODELE MODÈLE	EFP 1000 EG	EFP 1500 EG	EFP 2000 EG	EFP 1000 II	EFP 1500 II	EFP 2000 II
<b>Precio</b> Price Prix						
<b>Medidas</b> Measures [mm] Mesures	1004 x 550 x 880 mm.	1479 x 550 x 880 mm.	1954 x 550 x 880 mm.	1004 x 550 x 880 mm.	1479 x 550 x 880 mm.	1954 x 550 x 880 mm.
<b>Temperatura</b> Temperature Température [°C]	<b>+3°C/+6°C</b>					
<b>Clase Climática</b> Climatic class Classe climatique [°C]	4 / 38°C					
<b>Tensión/Frecuencia</b> Electrical data Tension électrique	230V/1ph/50Hz					
<b>Controlador</b> Controller Régulateur	Termostático / Thermostatic / Thermostatique					
<b>Material</b> Material [EXT/INT] Matériel	Exterior plastificado blanco / Encimera INOX AISI 304 Exterior prepainted / INOX AISI 304 worktop Extérieur plastifié blanc / Dessus INOX AISI 304			Encimera INOX AISI 304 / Interior-Exterior AISI 430 INOX AISI 304 Worktop / AISI 430 Interior-Exterior Dessus INOX AISI 304 / Intérieur-Extérieur AISI 430		
<b>Espesor</b> Thickness Épaisseur [mm]	40					
<b>Aislamiento</b> Isolation Isolation [mm]	40kg/m <sup>3</sup> / Free CFC's / Zero ODP-GWP					
<b>Capacidad</b> Capacity Capacité [L]	200	305	415	200	305	415
<b>Puertas</b> Doors Portes	2	3	4	2	3	4
<b>Nº separadores</b> Nº dividers Nº séparateurs	1	2	3	1	2	3
<b>Sistema de frío</b> Cooling System Système de froid	Condensación Forzado / Forced air condensation / Condensation Ventilée Evaporador estático / Static evaporator / Évaporateur statique					
<b>Desescarche</b> Defrost Dégivrage	-					
<b>Expansión</b> Expansion Expansion	Capilar / Capillary / Capillaire					
<b>Potencia</b> Power Puissance [W]	122	180	180	122	180	180
<b>Potencia frig.</b> Cooling capacity Puissance Frig. [W A -10°C]	169	370	370	169	370	370
<b>Consumo</b> Consumption Consommation [kWh/ 24h]	-					
<b>Clase energética</b> Energy class Classe Énerg.	-					
<b>Refrigerante</b> Refrigerant Gaz	<b>R-600a</b>	<b>R-290</b>		<b>R-600a</b>	<b>R-290</b>	
<b>Opcional</b> Optional Options	Separador / Divider / Séparateur [504X26] 115V/1 ph/60 Hz 230V/1 ph/60 Hz					

Serie / Series / Série **EFP**

+Info: [www.infrico.com](http://www.infrico.com)



EFP 2000 EG

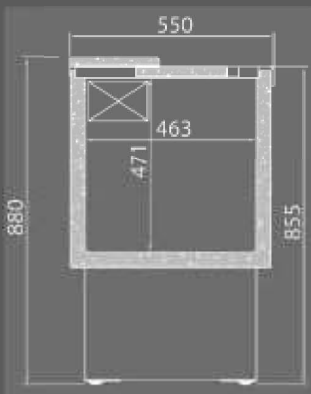

EFP 1000 II



EFP 1500 EG



# Refrigerador de botellas / Chest bottle cooler / Refrigerateur de bouteilles (EB)

# Refrigerador de botellas con cajones / Chest bottle cooler with drawers / Refrigerateur de bouteilles avec tiroirs (EBC)



MODELO MODELE MODÈLE							
<b>Precio</b> Price Prix							
<b>Medidas</b> Measures [mm] Mesures	1004 x 550 x 865 mm.	1479 x 550 x 865 mm.	1954 x 550 x 865 mm.	2429 x 550 x 865 mm.	1004 x 550 x 865 mm.	1479 x 550 x 865 mm.	1954 x 550 x 865 mm.
<b>Temperatura</b> Temperature Température	+3°C/+6°C						
<b>Clase Climática</b> Climatic class Classe climatique	4 / 38°C						
<b>Tensión/Frecuencia</b> Electrical data Tension électrique	230V/1ph/50Hz						
<b>Controlador</b> Controller Régulateur	-						
<b>Material</b> Material [EXT/INT] Matériel	Encimera INOX AISI 304 / Interior-Exterior AISI 430 INOX AISI 304 Worktop / AISI 430 Interior-Exterior Dessus INOX AISI 304 / Interior-Extérieur AISI 430						
<b>Espesor</b> Thickness Épaisseur	40						
<b>Aislamiento</b> Isolation Isolation	40kg/m <sup>3</sup> / Free CFC's / Zero ODP-GWP						
<b>Capacidad</b> Capacity Capacité	265	445	620	800	265	445	620
<b>Puertas</b> Doors Portes	2	3	4	5	2	3	4
<b>Nº Separadores</b> Nº Dividers Nº Séparateur	1	2	3	4	1	2	3
<b>Sistema de frío</b> Cooling System Système de froid	Forzado / Forced air / Ventilé Evaporador estático / Static evaporator / Évaporateur statique						
<b>Desescarche</b> Defrost Dégivrage	-						
<b>Expansión</b> Expansion Expansion	Capilar / Capillary / Capillaire						
<b>Potencia</b> Power Puissance	122	180	180	355	122	180	180
<b>Potencia frig.</b> Cooling capacity Puissance Frig.	169	370	370	690	169	343	343
<b>Consumo</b> Consumption Consommation	-						
<b>Clase energética</b> Energy class Classe Énerg.	-						
<b>Refrigerante</b> Refrigerant Gaz	<b>R-600a</b>	<b>R-290</b>			<b>R-600a</b>	<b>R-290</b>	
<b>Opcional</b> Optional Options	Separador / Divider / Séparateur [504X32]						
	115V/1 ph/60 Hz 230V/1 ph/60 Hz						

Serie / Series / Série **EB / EBC**

+Info: [www.infrico.com](http://www.infrico.com)



EBC 2000 II

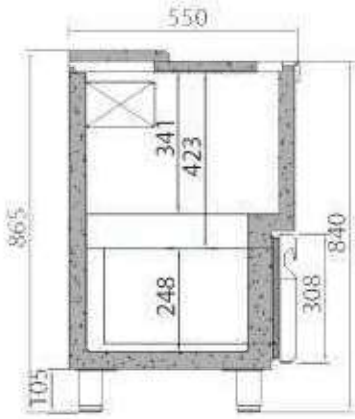
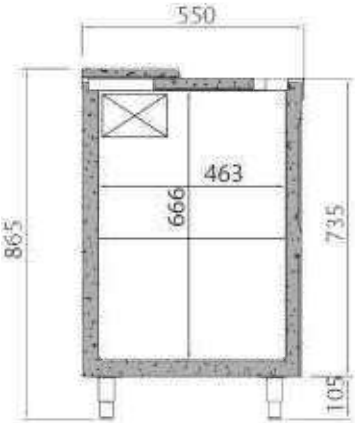

EB 1000 II



EBC 1000 II



# Expositor refrigerado horizontal altura 850mm / Back-Bar 850mm height / Arrière bar horizontal hauteur 850mm

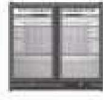

MODELO  
MODELE  
MODÈLE

ERV 15 SH

ERV 25 SH

ERV 35 SH

ERV 15 II SH

ERV 25 II SH

ERV 35 II SH

Precio Price Prix							
Medidas Measures [mm] Mesures	↔ ↗ ↕	600 x 510 x 850 mm.	900 x 510 x 850 mm.	1350 x 510 x 850 mm.	600 x 510 x 850 mm.	900 x 510 x 850 mm.	1350 x 510 x 850 mm.
Temperatura Temperature Température	[°C]	+4°C/+12°C					
Clase Climática Climatic class Classe climatique	[°C]	4 / 38°C					
Tensión/Frecuencia Electrical data Tension électrique		230V/1ph/50Hz					
Controlador Controller Régulateur		Digital / Digital / Électronique IP65					
Material Material [EXT/INT] Matériel		Exterior acero plastificado negro / Interior acero plastificado gris Black plastic coated steel exterior / Grey plastic coated steel interior Extérieur acier plastifié noir / Intérieur acier plastifié gris			Interior plastificado gris / Exterior INOX AISI 430 Interior prepainted grey / INOX AISI 430 Exterior Intérieur plastifié gris / Extérieur INOX AISI 430		
Espesor Thickness Épaisseur	[mm]	30					
Aislamiento Isolation Isolation	[mm]	40kg/m <sup>3</sup> / Free CFC's / Zero ODP-GWP					
Capacidad Capacity Capacité	[L]	124	193	296	124	193	296
Puertas Doors Portes		1	2	3	1	2	3
Nº parrillas J. guías Nº shelves / Slides Nº de grilles / Glissière		2	2	2	2	2	2
Sistema de frío Cooling System Système de froid		Forzado / Forced air / Ventilé					
Desescarche Defrost Dégivrage		Automático / Automatic / Automatique					
Expansión Expansion Expansion		Capilar / Capillary / Capillaire					
Potencia Power Puissance	[W]	250	320	259	250	320	259
Potencia frig. Cooling capacity Puissance Frig.	[W A -10°C]	370					
Consumo Consumption Consommation	[kWh/ 24h]	-					
Clase energética Energy class Classe Énerg.		-					
Refrigerante Refrigerant Gaz		R-290					
Opcional Optional Options		Iluminación Led RGB con cambio de color [por puerta] / Led lighting RGB change of colour [per door] / LED RGB avec changement de couleur [par porte] 115V/1 ph/60 Hz 230V/1 ph/60 Hz					

Serie / Series / Série **ERV**

+Info: [www.infrico.com](http://www.infrico.com)

ERV 25 SH



Controlador digital IP 65.  
Digital control IP65  
Contrôleur digital IP 65.

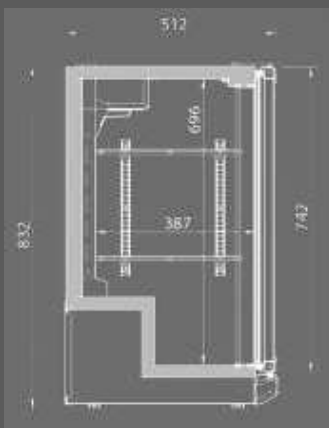

ERV 35 II SH

# Expositor refrigerado horizontal altura 920mm / Back-Bar 920mm height / Arrière bar horizontal hauteur 920mm



Puertas correderas  
Sliding doors  
Portes coulissantes

MODELO  
MODELE  
MODÈLE



ERV 15 PP



ERV 25 PP



ERV 35 PP



ERV 15



ERV 25



ERV 35



ERV 25 C

Precio Price Prix								
Medidas Measures (mm) Mesures	↔ ↕	600 x 510 x 920 mm.	900 x 510 x 920 mm.	1350 x 510 x 920 mm.	600 x 510 x 920 mm.	900 x 510 x 920 mm.	1350 x 510 x 920 mm.	900 x 510 x 920 mm.
Temperatura Temperature Température	[°C]	+4°C/+8°C			+4°C/+12°C			
Clase Climática Climatic class Classe climatique	[°C]	4 / 38°C						
Tensión/Frecuencia Electrical data Tension électrique		230V/1ph/50Hz						
Controlador Controller Régulateur		Digital / Digital / Électronique IP65						
Material Material (EXT/INT) Matériel		Exterior acero plastificado negro / Interior acero plastificado gris Black plastic coated steel exterior / Grey plastic coated steel interior Extérieur acier plastifié noir / Intérieur acier plastifié gris						
Espesor Thickness Épaisseur	[mm]	30						
Aislamiento Isolation Isolation	[mm]	40kg/m <sup>3</sup> / Free CFC's / Zero ODP-GWP						
Capacidad Capacity Capacité	[L]	140	220	330	140	220	330	220
Puertas Doors Portes		1	2	3	1	2	3	2
N° parrillas / Guías N° shelves / Slides N° de grilles / Glissière		2						
Sistema de frío Cooling System Système de froid		Forzado / Forced air / Ventilé						
Desescarche Defrost Dégivrage		Automático / Automatic / Automatique						
Expansión Expansion Expansion		Capilar / Capillary / Capillaire						
Potencia Power Puissance	[W]	250	320	325	250	320	325	320
Potencia frig. Cooling capacity Puissance Frig.	[W A -10°C]	370						
Consumo Consumption Consommation	[kWh/ 24h]	-						
Clase energética Energy class Classe Énerg.		-						
Refrigerante Refrigerant Gaz		R-290						
Opcional Optional Options		Iluminación Led RGB con cambio de color (por puerta) / Led lighting RGB change of colour (per door) / LED RGB avec changement de couleur (par porte) Parrilla / Wire shelf / Grille ERV15 (502X27) Parrilla / Wire shelf / Grille ERV25 (502X26) Parrilla / Wire shelf / Grille ERV35 (502X31) 115V/1 ph/60 Hz 230V/1 ph/60 Hz						

Serie / Series / Série **ERV**

+Info: [www.infrico.com](http://www.infrico.com)

ERV 25 PP



**Video del producto**  
Product Video  
Vidéo du produit



**Infrico Youtube**



ERV 15



ERV 25

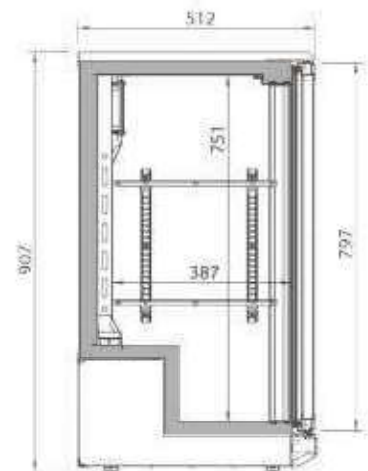

# Expositor refrigerado horizontal altura 920mm / Back-Bar 920mm height / Arrière bar horizontal hauteur 920mm

REFRIGERACIÓN / REFRIGERATOR / POSITIF / 920mm ↓

MODELO  
MODELE  
MODÈLE



ERV 15 II

ERV 25 II

ERV 35 II

ERV 15 PP II

ERV 25 PP II

ERV 35 PP II

Precio Price Prix							
Medidas Measures [mm] Mesures	↔ ↗ ↕	600 x 510 x 920 mm.	900 x 510 x 920 mm.	1350 x 510 x 920 mm.	600 x 510 x 920 mm.	900 x 510 x 920 mm.	1350 x 510 x 920 mm.
Temperatura Temperature Température	[°C]	+4°C/+12°C					
Clase Climática Climatic class Classe climatique	[°C]	4 / 38°C					
Tensión/Frecuencia Electrical data Tension électrique		230V/1ph/50Hz					
Controlador Controller Régulateur		Digital / Digital / Électronique IP65					
Material Material [EXT/INT] Matériel		Interior plastificado gris / Exterior INOX AISI 430 Interior prepainted / INOX AISI 430 Exterior Intérieur plastifié gris / Extérieur INOX AISI 430					
Espesor Thickness Épaisseur	[mm]	30					
Aislamiento Isolation Isolation	[mm]	40kg/m <sup>3</sup> / Free CFC's / Zero ODP-GWP					
Capacidad Capacity Capacité	[L]	140	220	330	140	220	330
Puertas Doors Portes		1	2	3	1	2	3
Nº parrillas / Guías N° shelves / Slides N° de grilles / Glissière		2					
Sistema de frío Cooling System Système de froid		Forzado / Forced air / Ventilé					
Desescarche Defrost Dégivrage		Automático / Automatic / Automatique					
Expansión Expansion Expansion		Capilar / Capillary / Capillaire					
Potencia Power Puissance	[W]	250	320	325	250	320	325
Potencia frig. Cooling capacity Puissance Frig.	[W A -10°C]	370					
Consumo Consumption Consommation	[kWh/ 24h]	-					
Clase energética Energy class Classe Énerg.		-					
Refrigerante Refrigerant Gaz		R-290					
Opcional Optional Options		Iluminación Led RGB con cambio de color (por puerta) / Led lighting RGB change of colour (per door) / LED RGB avec changement de couleur (par porte)  Parrilla / Wire shelf / Grille ERV15 (502X27)  Parrilla / Wire shelf / Grille ERV25 (502X28)  Parrilla / Wire shelf / Grille ERV35 (502X31)  115V/1 ph/60 Hz  230V/1 ph/60 Hz					

Serie / Series / Série **ERV INOX / ERV PP**

+Info: [www.infrico.com](http://www.infrico.com)

ERV 25 PP II



Controlador digital IP 65.  
Digital control IP65  
Contrôleur digital IP 65.



ERV 35 II

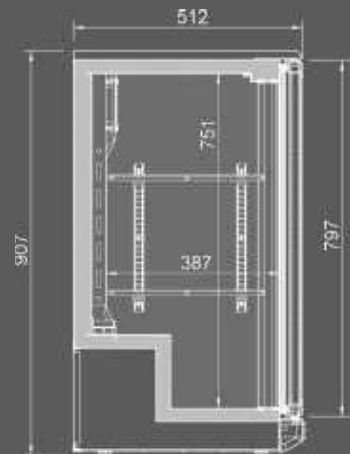



**Expositor refrigerado vertical /  
Glass door merchandiser /  
Armoire d'exposition réfrig. verticale**

**Expositor refrigerado vertical /  
Glass door merchandiser /  
Armoire d'exposition réfrig. verticale**

REFRIGERACIÓN / REFRIGERATOR / POSITIF



MODELO  
MODELE  
MODÈLE

ERV 53

ERV 83

ERC 36 B

ERC 100

ERC 130

ERC 200

Precio Price Prix								
Medidas Measures (mm) Mesures	↔ ↕	600 x 510 x 1820 mm.	900 x 510 x 1820 mm.	620 x 595 x 1870 mm.	1385 x 704 x 2005 mm.	1385 x 804 x 2005 mm.	2081 x 804 x 2005 mm.	
Temperatura Temperature Température	[°C]	+4°C/+12°C			+4°C/+8°C			
Clase Climática Climatic class Classe climatique	[°C]	4 / 38°C						
Tensión/Frecuencia Electrical data Tension électrique		230V/1ph/50Hz						
Controlador Controller Régulateur		Digital / Digital / Électronique IP65						
Material Material (EXT/INT) Matériel		Ext. acero plastif. negro / Int. acero plastificado gris Black plastic coated steel ext. / Grey plastic coated steel int. Ext. acier plastifié noir / Int. acier plastifié gris			Ext./Int acero plastificado blanco White plastic coated steel exterior/interior Extérieur/Intérieur acier plastifié blanc			
Espesor Thickness Épaisseur	(mm)	30			50			
Aislamiento Isolation Isolation	(mm)	40kg/m <sup>3</sup> / Free CFC's / Zero ODP-GWP						
Capacidad Capacity Capacité	(L)	280	435	355	1110	1310	2030	
Puertas Doors Portes		1	2	1	2		3	
Nº parrillas / Guías Nº shelves / Slides Nº de grilles / Glissière		5			4			
Sistema de frío Cooling System Système de froid		Ventilado / Forced air / Ventilé						
Desescarche Defrost Dégivrage		Parada de compresor / Compressor off / Arrêt du compresseur						
Expansión Expansion Expansion		Capilar / Capillary / Capillaire					Válvula termostática / Expansion valve / Détendeur thermostatique	
Potencia Power Puissance	(W)	190	443	400	795	787	1111	
Potencia frig. Cooling capacity Puissance Frig.	(W A -10°C)	370	690	370	950	1296	1440	
Consumo Consumption Consommation	(kWh/ 24h)	1,67	3,39	-	5,8	6,8	9,2	
Clase energética Energy class Classe Énerg.		<b>A</b>	<b>B</b>	-	<b>B</b>	<b>C</b>		
Refrigerante Refrigerant Gaz		<b>R-290</b>						
Opcional Optional Options		Iluminación Led RGB con cambio de color (por puerta) / Led lighting RGB change of colour (per door) / LED RGB avec changement de couleur (par porte)		Iluminación Led RGB con cambio de color (por puerta) / Led lighting RGB change of colour (per door) / LED RGB avec changement de couleur (par porte)				
		Parrilla / Wire shelf / Grille ERV53 (502X27)		115V/1 ph/60 Hz 230V/1 ph/60 Hz				
		Parrilla / Wire shelf / Grille ERV83 (502X28)						
		Cabezal iluminado / Illuminated canopy / Bandeau lumineux		-				Interior - Exterior / Interior - Exterior / Intérieur - extérieur Negro / Black / Noir RAL 9017

Serie / Series / Série **ERV**  
 Serie / Series / Série **ERC**

+Info: [www.infrico.com](http://www.infrico.com)

Cabezal iluminado  
 Canopy illuminated  
 Bandeau lumineux



ERC 200

ERC 130 / 200

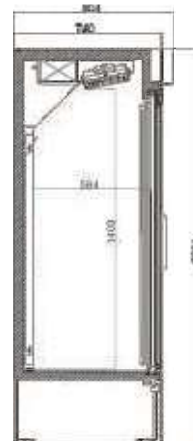

ERC 100



ERV 83

Video del producto  
 Product Video  
 Vidéo du produit



Infrico Youtube

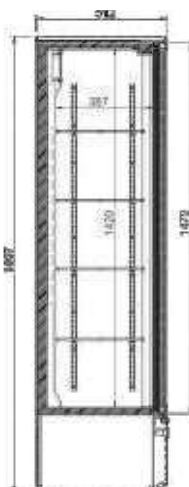

ERC 36 B

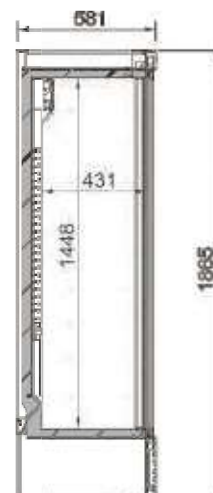

# Expositor refrigerado vertical / Glass door merchandiser / Armoire d'exposition réfrig. verticale

MODELO  
MODELE  
MODÈLE

**NEW**



ERC 50 PH

**NEW**



ERC 50 PH BT



ERC 130 PH



ERC 130 PH BT



ERC 200 PH



ERC 200 PH BT

<b>Precio</b> Price Prix						
<b>Medidas</b> Measures (mm) Mesures	687 x 842 x 2003 mm.		1384 x 842 x 2003 mm.		2081 x 842 x 2003 mm.	
<b>Temperatura</b> Temperature Température	+4°C/+8°C	-18°C	+4°C/+8°C	-18°C	+4°C/+8°C	-18°C
<b>Clase Climática</b> Climatic class Classe climatique	4 / 38°C					
<b>Tensión/Frecuencia</b> Electrical data Tension électrique	230V/1ph/50Hz					
<b>Controlador</b> Controller Régulateur	Digital / Digital / Électronique IP65					
<b>Material</b> Material (EXT/INT) Matériel	Int acero plastificado blanco / Ext acero plastificado negro White plastic coated steel interior / Black plastic coated steel exterior Intérieur acier plastifié blanc / Extérieur acier plastifié noir					
<b>Espesor</b> Thickness Épaisseur	55					
<b>Aislamiento</b> Isolation Isolation	40kg/m <sup>3</sup> / Free CFC's / Zero ODP-GWP					
<b>Capacidad</b> Capacity Capacité	500		1310		2030	
<b>Puertas</b> Doors Portes	1		2		3	
<b>Nº estantes</b> Nº shelves Nº d'étagères	4		4		8	
<b>Sistema de frío</b> Cooling System Système de froid	Ventilado / Forced air / Ventilé					
<b>Desescarche</b> Defrost Dégivrage	Parada compresor / Compresor off / Arrêt compresseur.	Gas caliente / Hot gas / Gaz chaud	Parada compresor / Compresor off / Arrêt compresseur.	Gas caliente / Hot gas / Gaz chaud	Parada compresor / Compresor off / Arrêt compresseur.	Gas caliente / Hot gas / Gaz chaud
<b>Expansión</b> Expansion Expansion	Capilar / Capillary / Capillaire			Válvula termostática / Expansion valve / Détendeur thermostatique		
<b>Potencia</b> Power Puissance	414	662	844	890	1123	1960
<b>Potencia frig.</b> Cooling capacity Puissance Frig.	690	583	1296		1559	1484
<b>Consumo</b> Consumption Consommation	4,22	8,23	6,8	16,6	9,2	28
<b>Clase energética</b> Energy class Classe Énerg.	<b>C</b>	<b>C</b>	<b>C</b>	<b>D</b>	<b>C</b>	<b>D</b>
<b>Refrigerante</b> Refrigerant Gaz	<b>R-290</b>					
<b>Opcional</b> Optional Options	<p>Iluminación Led RGB con cambio de color (por puerta) / Led lighting RGB change of colour (per door) / LED RGB avec changement de couleur (par porte) Kit Portaprecios ERC 100/130 [KPPER13] Kit Portaprecios ERC200 [KPPER20] 115V/1 ph/60 Hz 230V/1 ph/60 Hz Interior - Exterior / Interior - Exterior / Intérieur - extérieur</p> <div style="display: flex; justify-content: space-around; align-items: center;"> <div style="text-align: center;"> <p>Total Negro / Black / Noir RAL 9017</p> </div> <div style="text-align: center;"> <p>Total Blanco / White / Blanc RAL 9016</p> </div> </div>					

Serie / Series / Série **MINIMARKET**

+Info: [www.infrico.com](http://www.infrico.com)



ERC200PH



Controlador digital IP 65.  
Digital control IP65  
Contrôleur digital IP 65.

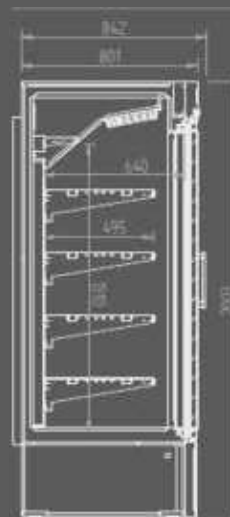

Video del producto  
Product Video  
Vidéo du produit



Infrico Youtube

**NEW**



ERC50PH



ERC130PH



ERC200PH BT

# Expositor de refrigeración y congelación / Glass door merchandiser refrigerator and freezer / Armoire d'exposition réfrigération et congélation

REFRIGERACIÓN / REFRIGERATOR / POSITIVE

CONGELACIÓN / FREEZER / NÉGATIVE



MODELO  
MODELE  
MODÈLE

NEC501RV

NEC1002RV

NEC401FS

NEC501FV

NEC1002FV

<b>Precio</b> Price Prix					
<b>Medidas</b> Measures [mm] Mesures	↔ ↕	687 x 705 x 2010 mm.	1385 x 705 x 2010 mm.	687 x 670 x 2010 mm.	687 x 705 x 2010 mm.
<b>Temperatura</b> Temperature [°C] Température		<b>+2°C/+8°C</b>		<b>-15°C/-25°C</b>	
<b>Clase Climática</b> Climatic class [°C] Classe climatique		4 / 38°C			
<b>Tensión/Frecuencia</b> Electrical data Tension électrique		230V/1ph/50Hz			
<b>Controlador</b> Controller Régulateur		Digital / Digital / Électronique IP65			
<b>Material</b> Material [EXT/INT] Matériel		Ext/Int acero plastificado blanco / White plastic coated steel exterior/interior / Extérieur/Intérieur acier plastifié blanc			
<b>Espesor</b> Thickness [mm] Épaisseur		50			
<b>Aislamiento</b> Isolation [mm] Isolation		40kg/m <sup>3</sup> / Free CFC's / Zero ODP-GWP			
<b>Capacidad</b> Capacity [L] Capacité		500	1000	430	500
<b>Puertas</b> Doors Portes		1	2	1	2
<b>Nº parrillas / Guías</b> Nº shelves / Slides Nº de grilles / Glissière		5 [530x460]	10 [530x510]	5 [438x556]	10 [530x510]
<b>Sistema de frío</b> Cooling System Système de froid		Forzado / Forced air / Ventilé		Estático / Static / Statique	Forzado / Forced air / Ventilé
<b>Desescarche</b> Defrost Dégivrage		Parada de compresor / Compressor off / Arrêt du compresseur		Manual	Gas caliente / Hot gas defrost / Gaz chaud
<b>Expansión</b> Expansion Expansion		Capilar / Capillary / Capillaire			Termostática / Thermostatic / Thermostatique
<b>Potencia</b> Power [W] Puissance		414	445	487	662
<b>Potencia frig.</b> Cooling capacity [W A] Puissance Frig. -10/-30°C		690		445	583
<b>Consumo</b> Consumption [kWh/ 24h] Consommation		4,22	5,05	-	8,23
<b>Clase energética</b> Energy class Classe Énerg.		<b>C</b>	<b>B</b>	-	<b>C</b>
<b>Refrigerante</b> Refrigerant Gaz		<b>R-290</b>			
<b>Opcional</b> Optional Options		Iluminación Led RGB con cambio de color [por puerta] / Led lighting RGB change of colour [per door] / LED RGB avec changement de couleur [par porte]			
		115V/1 ph/60 Hz 230V/1 ph/60 Hz		115V/1 ph/60 Hz 230V/1 ph/60 Hz	
		Exterior [Solo Puerta, Cuadro y Rejilla] / Exterior [door, control panel and grille] / extérieur [porte, bandeau et grille] Negro / Black / Noir RAL 9017			

Serie / Series / Série **NEC**

+Info: [www.infrico.com](http://www.infrico.com)

NEC1002FV



Controlador digital IP 65.  
Digital control IP65  
Contrôleur digital IP 65.



**Cabezal iluminado**  
Canopy illuminated  
Bandeau lumineux

**Triple acristalamiento templado, bajo emisivo con carga de Argón (4-12-3-12-4)**  
Triple tempered glass, low emission with Argon charge (4-12-3-12-4)  
Triple vitrage trempé à faible émissivité avec Argon (4-12-3-12-4)

NEC501FV

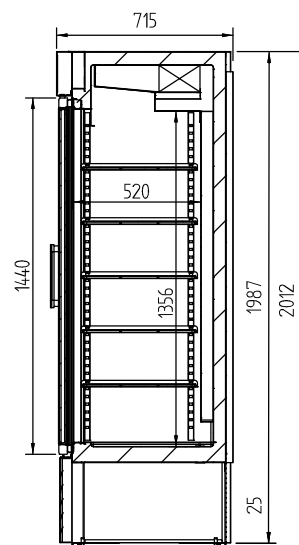

# Enfriador de botellas Supercooler / Chest bottle cooler Supercooler / Réfrigérateur de bouteilles Supercooler



SPC501



SPC501B

MODELO  
MODELE  
MODÈLE

<b>Precio</b> Price Prix		
<b>Medidas</b> Measures [mm] Mesures	↔ ↕	687 x 728 x 2003 mm.
<b>Temperatura</b> Temperature [°C] Température		+0°C/-8°C
<b>Clase Climática</b> Climatic class [°C] Classe climatique		4 / 38°C
<b>Tensión/Frecuencia</b> Electrical data Tension électrique		230V/1ph/50Hz
<b>Controlador</b> Controller Régulateur		Digital / Digital / Électronique IP65
<b>Material</b> Material [EXT/INT] Matériel		Int: acero Inox AISI 430 / Ext: acero Inox AISI 304 Int: Stainless Steel AISI 430 / Ext: Stainless Steel AISI 304 Int: Stainless Steel AISI 430 / Ext: Acier Inox AISI 304
<b>Espesor</b> Thickness [mm] Épaisseur		50
<b>Aislamiento</b> Isolation [mm] Isolation		40kg/m <sup>3</sup> / Free CFC's / Zero ODP-GWP
<b>Capacidad</b> Capacity [L] Capacité		500
<b>Puertas</b> Doors Portes		1
<b>Nº Estantes</b> Shelving Nº d' étagères		5 [560x480]
<b>Sistema de frío</b> Cooling System Système de froid		Forzado / Forced air / Ventilé
<b>Desescarche</b> Defrost Dégivrage		Gas caliente / Hot gas / Gaz chaud
<b>Expansión</b> Expansion Expansion		Capilar / Capillary / Capillaire
<b>Potencia</b> Power [W] Puissance		757
<b>Potencia frig.</b> Cooling capacity [W] Puissance Frig. -10/-30°C		650
<b>Consumo</b> Consumption [kWh/24h] Consommation		-
<b>Clase energética</b> Energy class Classe Énerg.		-
<b>Refrigerante</b> Refrigerant Gaz		<b>R-290</b>
<b>Opcional</b> Optional Options		Parrilla / Wire shelf / Grille métallique [502x119]  115V/1 ph/60 Hz 230V/1 ph/60 Hz

Serie / Series / Série **SPC**

+Info: [www.infrico.com](http://www.infrico.com)



SPC501



Bebida en estado  
**líquido**  
sin congelar.



Temperatura  
**bajo cero**  
en menos de **2h.**



Tecnología  
**aplicable a**  
todo tipo  
de **bebidas**



SPC501B



SPC501

**Triple acristalamiento templado, bajo emisivo con carga de Argón (4-12-3-12-4)**  
Triple tempered glass, low emission with Argon charge (4-12-3-12-4)  
Triple vitrage trempé à faible émissivité avec Argon (4-12-3-12-4)

Grado de alcohol Alcoholic strength Teneur en alcool	Punto de corte Set point Point de coupure
5% < 5,5%	-7°
4% < 5%	-6°
3,5% < 4%	-5°
<b>Cerveza/Beer/Bière 0,0%</b>	<b>-2°</b>
<b>Refrescos carbonatados/ Carbonated beverages Boissons gazeuses (non alcoolisées)</b>	<b>-2°</b>

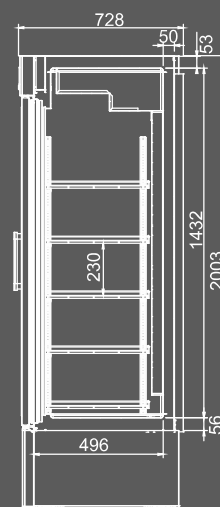



# Escarchador de copas / Glass froster counter / Mini congélateur verticale

# Tanque enfriador de agua / Water tank cooler / Refrigidisseurs d'eau

CONGELACIÓN / FREEZER / NÉGATIF

REFRIGERACIÓN / REFRIGERATOR / POSITIF

MODELO  
MODELE  
MODÈLE



ESC 50



ESC 50 CR



TA 100 II



TA 180 II

Precio Price Prix				
Medidas Measures (mm) Mesures	↔ ↗ ↕	570 x 600 x 850 mm.	570 x 600 x 850 mm.	1312 x 562 x 570 mm.
Temperatura Temperature Température	[°C]	-5°C/-18°C	-5°C/-10°C	+1°C/+4°C
Clase Climática Climatic class Classe climatique	[°C]	4 / 38°C		
Tensión/Frecuencia Electrical data Tension électrique		230V/1ph/50Hz		
Controlador Controller Régulateur		Digital / Digital / Électronique IP65		
Material Material Matériel	[EXT/INT]	AISI 304		
Espesor Thickness Épaisseur	[mm]	60		
Aislamiento Isolation Isolation	[mm]	40kg/m <sup>3</sup> / Free CFC's / Zero ODP-GWP		
Capacidad Capacity Capacité	[L]	95	95	100
Puertas Doors Portes		1	1	-
Nº parrillas / Guías Nº shelves / Slides Nº de grilles / Glissière		2 (400 x 430)	2 (400 x 430)	-
Sistema de frío Cooling System Système de froid		Condensación Forzado / Forced air condensation / Condensation Ventilé Evaporador estático / Static evaporator / Évaporateur statique		Forzado / Forced air / Ventilé
Desescarche Defrost Dégivrage		-		
Expansión Expansion Expansion		Capilar / Capillary / Capillaire		
Potencia Power Puissance	[W]	315	323	555
Potencia frig. Cooling capacity Puissance Frig.	[W A -10°C]	306	306	1041
Consumo Consumption Consommation	[kWh/ 24h]	-		
Clase energética Energy class Classe Énerg.		-		
Refrigerante Refrigerant Gaz		R-290		
Opcional Optional Options		Juego de guías / Slides / Jeu de Glissières [503X11] Parrilla / Wire shelf / Grille [502X45]		Soporte enfriador / Wall hangers / Support [STA] KIT Filtro agua / Water filter / Filtre à eau [4600x0018]
		115V/1 ph/60 Hz 230V/1 ph/60 Hz		115V/1 ph/60 Hz 230V/1 ph/60 Hz

Serie / Series / Série **ESC / TA**

+Info: [www.infrico.com](http://www.infrico.com)

ESC 50



ESC 50 CR

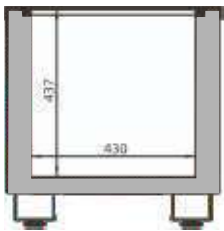

**Opción Kit filtro de agua**  
Option Kit water filter  
Optionel Kit filtre à eau



**Serpentín interior en Acero Inoxidable**  
Stainless Steel interior coil  
Serpentín intérieur en Acier Inoxydable

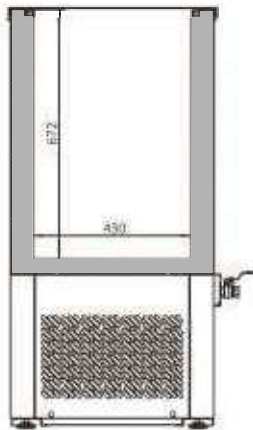

TA 100 II



TA 180 II



+Info: [www.infrico.com](http://www.infrico.com)



# Mesas

Tables / Tables

2





lafrico

4.0

Serie / Series / Série

## 600



BMPP II  
 BMPP BT  
 BMPP CR  
 BMPP F II  
 BMPP GR  
 BMPP GR BT  
 BMPP EN \_\_\_\_\_ 60-65

NEW

Serie / Series / Série

## MSG/MPG



MSG  
 MSG BT \_\_\_\_\_ 66-67

NEW

Serie / Series / Série

## 700GN1/1



BMGN A+  
 BMGN II  
 BMGN BT  
 BMGN CR  
 BMGN F II  
 BMGN GR  
 BMGN GR BT  
 BMGN EN  
 BMGN PDC \_\_\_\_\_ 68-77

Serie / Series / Série

## ME



MPG  
 ME VIP  
 ME BAN  
 ME EN  
 ME II  
 ME PIZZA  
 ME KB \_\_\_\_\_ 76-81

NEW

Serie / Series / Série

## BARSTATION



BST \_\_\_\_\_ 82-83

Serie / Series / Série

## 800MR



MR  
 MR BT  
 MR CR  
 MR GR  
 MR PDC  
 MR PD CR  
 MR EN  
 MR H \_\_\_\_\_ 84-91

Serie / Series / Série

## 800MPL/MP



MPL  
 MP  
 MP CN \_\_\_\_\_ 92-93

Serie / Series / Série

## FMPP



FMPP II  
 FMPP CR  
 FMPP GR \_\_\_\_\_ 94-95

Serie / Series / Série

## MCAF/ME/MT



MCAF  
 MCAF CD  
 MCAF CI  
 ME 30  
 ME 60  
 MT 60  
 MT 70 \_\_\_\_\_ 96-97

+Info: [www.infrico.com](http://www.infrico.com)





## 2. Mesas Undercounters / Tables

Nuevo controlador digital táctil e intuitivo IP 65.

New digital control easy and intuitive-touch screen IP65 protection.

Nouveau contrôleur digital tactile e intuitif IP 65.



Encimera reforzada con Omegas de serie [series 600/700].

Reinforced worktop with Omegas as standard [600/700 series].

Plan de travail renforcé avec Omegas en standard [séries 600/700].



Doble acristalamiento templado, bajo emisivo con carga de Argón [4-27-4].

Double tempered glass, low-e with argon charge [4-27-4].

Double vitrage et verre trempé [4-12-3-12-4].



Encimera con fregadero opcional [BMPP F - BMGN F]

Worktop with optional sink [BMPP F - BMGN F]

Plan de travail avec évier optionnel [BMPP F - BMGN F]



Opcional: Manejo del control digital por WiFi o Bluetooth®

Optional: Operating digital control by WiFi or Bluetooth®

Optionnel: Fonctionnement de la commande numérique par WiFi ou Bluetooth®

### Iluminación / Lighting / Éclairage

Incorporación de iluminación LED, llegando a reducir el consumo energético entre un 80% y 90%, respecto a una bombilla tradicional. RGB opcional.

LED lighting incorporated, reducing energetic consumption between 80% and 90% respect to a traditional light bulb. RGB optional.

Éclairage LED, réduisant la consommation énergétique entre 80% et 90%, par rapport à une ampoule traditionnelle. RGB optionnel.

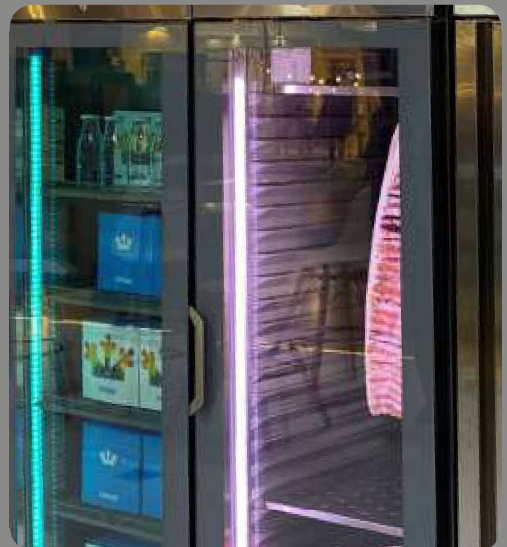

+Info: [www.infrico.com](http://www.infrico.com)



Puertas con tirador de doble agarre y burlete plano desmontable "cleanless".

Double handle doors and flat gasket easily removable "cleanless".

Portes avec double poignée et joint plat facilement démontable "cleanless".

Kit cajones / Drawers kit / Kit tiroirs

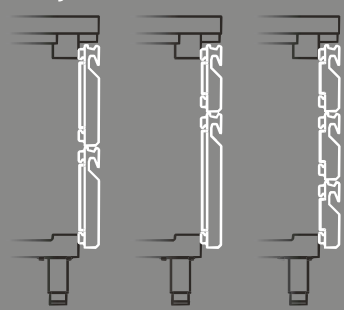

Nuevas guías Fulterer para cajones.

New Fulterer draw slides.

Nouveau glissières Fulterer pour tiroirs.

 **70kg**  
 **-25°C**



Refrigeración / Refrigeration / Réfrigération

Sistemas de frío ventilado. Bandejas evaporativas sin resistencia eléctrica para una mayor eficiencia energética. Sistemas de evaporación forzada. Evaporadores tratados con Epoxi de poliéster anticorrosión. Unidades sobredimensionadas y eficientes. Válvulas de expansión termostáticas y desescarches por gas caliente en baja temperatura. Marcos de puerta calefactados para evitar acumulación de hielo.

Forced air cooling systems. Energy-saving non-electric condensate pans. Forced evaporation systems. Evaporators treated with anti-corrosion polyester Epoxy. Oversized and efficient units. Expansion valves. Hot gas defrost. Heating door frames to prevent ice build-up.

Systèmes de froid ventilé. Bacs d'évaporation sans résistances électriques pour une meilleur efficacité énergétique. Systèmes d'évaporation forcé. Évaporateurs traités avec un époxy polyester anticorrosion. Unités efficaces et surdimensionnées. Valves d'expansion thermostatiques. Dégivrage par gaz chaud. Cadres de portes chauffés pour empêcher l'accumulation de glace.



## Mesa de refrigeración y congelación / Undercounter refrigerator and freezer / Desserte dessus de comptoir positive et négative

MODELO  
MODELE  
MODÈLE



BMPP 1500 II



BMPP 2000 II



BMPP 2500 II



BMPP 1500 BT



BMPP 2000 BT



BMPP 2500 BT

Precio Price Prix							
Medidas Measures (mm) Mesures		1468 x 600 x 850 mm.	1960 x 600 x 850 mm.	2452 x 600 x 850 mm.	1468 x 600 x 850 mm.	2452 x 600 x 850 mm.	
Temperatura Temperature Température	[°C]	-2°C/+8°C			-18°C		
Clase Climática Climatic class Classe climatique	[°C]	5 / 40° C			4 / 38°C		
Tensión/Frecuencia Electrical data Tension électrique		230V/1ph/50Hz					
Controlador Controller Régulateur		Digital IP65					
Material Material (EXT/INT) Matériel		AISI 304					
Espesor Thickness Épaisseur	(mm)	70					
Aislamiento Isolation Isolation	(mm)	40kg/m <sup>3</sup> / Free CFC's / Zero ODP-GWP					
Capacidad Capacity Capacité	[L]	250	385	510	250	385	510
Puertas Doors Portes		2	3	4	2	3	4
N° parrillas / Guías N° shelves / Slides N° de grilles / Glissière		2/2 (325x430)	3/3 (325x430)	4/4 (325x430)	2/2 (325x430)	3/3 (325x430)	4/4 (325x430)
Sistema de frío Cooling System Système de froid		Monoblock ventilado / Forced air monoblock / Monoblock ventilé					
Desescarche Defrost Dégivrage		Parada compresor / Compressor off / Arrêt du compresseur			Gas caliente / Hot gas / Gaz chaud		
Expansión Expansion Expansion		Capilar / Capillary / Capillaire			Válvula termostática / Expansion valve / Détendeur thermostatique		
Potencia Power Puissance	[W]	260	260	446	443	472	561
Potencia frig. Cooling capacity Puissance Frig.	[W A -10/-30°C]	370	370	690	445	445	540
Consumo Consumption Consommation	[kWh/ 24h]	1,55	1,80	2,05	4,02	6,57	6,78
Clase energética Energy class Classe Énerg.		<b>A</b>			<b>C</b>	<b>D</b>	<b>C</b>
Refrigerante Refrigerant Gaz		<b>R-290</b>					
Opcional Optional Options		115V/1ph/60Hz 230V/1ph/60Hz			115V/1ph/60Hz 230V/1ph/60Hz		
		Parrilla / Wire shelf / Grille (502X07) Cerradura / Lock / Serrure (506X209; 506X210) Juego de guías / Slides / Jeu de Glissières (GUIAC0115430, GUIAC0215430) Grupo lado contrario / Group opposite side / Groupe opposé [L]			Ruedas / Casters / Roulettes (705X16=2; 705X17=2) Sin peto trasero / Without backsplash / Sans dossieret		
		Kit cajones / Drawer Kit / Kit tiroirs BM 1/2 x 200 (JCAJ17BM1/2) BM 1/3 x 100 (JCAJ17BM1/3) BM 2/3 + BM 1/3 (JCAJ17BM2/3)			-		

Serie / Series / Série **600**

+Info: [www.infrico.com](http://www.infrico.com)

BMPP 2000 II



Controlador digital IP 65.  
Digital control IP65  
Contrôleur digital IP 65.





Opcional: Manejo control digital por WiFi o Bluetooth®

Optional: Operating digital control by WiFi or Bluetooth®

Circulación optimizada del aire  
Optimal air flow  
Circulation d'air optimisée



Sistema de ventilación de condensación frontal  
Front breathing condensation system  
Système de ventilation à condensation frontale



Refuerzo con Omegas.  
Omega reinforcement.  
Renforcement avec Omegas.



Kit 2 cajones  
2 drawers kit  
Kit 2 tiroirs  
BM 1/2 x 200



Kit 2 cajones  
2 drawers kit  
Kit 2 tiroirs  
BM 2/3x300 +  
BM 1/3x100



Kit 3 cajones  
3 drawers kit  
Kit 3 tiroirs  
BM 1/3x100

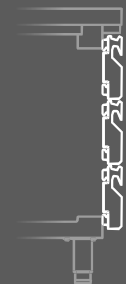

1/2                      2/3                      1/3  
302 x 418 x 205      302 x 418 x 307      302 x 418 x 105









KIT CAJONES / DRAWERS KIT / KIT TIROIRS (MOD. II)

**Mesa refrigerada puertas cristal /**  
**Glass Door undercounter refrigerator /**  
**Desserte dessus de comptoir posit. portes vitrées**

**Mesa refrigerada con fregadero /**  
**Sink undercounter refrigerator /**  
**Desserte dessus de comptoir posit. avec évier**

F= Fregadero / Sink / Evier

MODELO MODELE MODÈLE						
<b>Precio</b> Price Prix						
<b>Medidas</b> Measures (mm) Mesures	1468 x 600 x 850 mm.	1960 x 600 x 850 mm.	2452 x 600 x 850 mm.	1468 x 600 x 850 mm.	1960 x 600 x 850 mm.	2452 x 600 x 850 mm.
<b>Temperatura</b> Temperature Température	+2°C/+6°C			-2°C/+8°C		
<b>Clase Climática</b> Climatic class Classe climatique	4 / 38°C			5 / 40°C		
<b>Tensión/Frecuencia</b> Electrical data Tension électrique	230V/1ph/50Hz					
<b>Controlador</b> Controller Régulateur	Digital IP65					
<b>Material</b> Material (EXT/INT) Matériel	AISI 304					
<b>Espesor</b> Thickness Épaisseur	70					
<b>Aislamiento</b> Isolation Isolation	40kg/m <sup>3</sup> / Free CFC's / Zero ODP-GWP					
<b>Capacidad</b> Capacity Capacité	250	385	510	250	385	510
<b>Puertas</b> Doors Portes	2	3	4	2	3	4
<b>N° parrillas / Guías</b> N° shelves / Slides N° de grilles / Glissière	2/2 {325x430}	3/3 {325x430}	4/4 {325x430}	2/2 {325x430}	3/3 {325x430}	4/4 {325x430}
<b>Sistema de frío</b> Cooling System Système de froid	Monoblock ventilado / Forced air monoblock / Monoblock ventilé					
<b>Desescarche</b> Defrost Dégivrage	Parada compresor / Compressor off / Arrêt du compresseur					
<b>Expansión</b> Expansion Expansion	Capilar / Capillary / Capillaire					
<b>Potencia</b> Power Puissance	270	382	387	260	260	446
<b>Potencia frig.</b> Cooling capacity Puissance Frig.	370	690	690	370	370	690
<b>Consumo</b> Consumption Consommation	-	-	-	1,55	1,80	2,05
<b>Clase energética</b> Energy class Classe Énerg.	-			<b>A</b>	<b>A</b>	<b>A</b>
<b>Refrigerante</b> Refrigerant Gaz	<b>R-290</b>					
<b>Opcional</b> Optional Options	Juego de guías / Slides / Jeu de Glissières [GUIAC0115430, GUIAC0215430] Grupo lado contrario / Group opposite side / Groupe opposé [L] 115V/1ph/60Hz 230V/1ph/60Hz Kit cajones / Drawer Kit / Kit tiroirs BM 1/2 x 200 [JCAJ17BM1/2] BM 1/3 x 100 [JCAJ17BM1/3] BM 2/3 + BM 1/3 [JCAJ17BM2/3]					
	Parrilla / Wire shelf / Grille [502X43] Cerradura / Lock / Serrure [506X60] Iluminación Led RGB con cambio de color [por puerta] / Led lighting RGB change of colour [per door] / LED RGB avec changement de couleur [par porte]			Parrilla / Wire shelf / Grille [502X07] Cerradura / Lock / Serrure [506X209; 506X210]		

Serie / Series / Série **600**

+Info: [www.infrico.com](http://www.infrico.com)

**Doble cristal templado bajo emisivo más carga Argón 4-27-4**  
 Double tempered glass low-e + Argón 4-27-4  
 Double vitrage trempé à faible émissivité avec<sup>o</sup>

**BMPP 1500 CR**

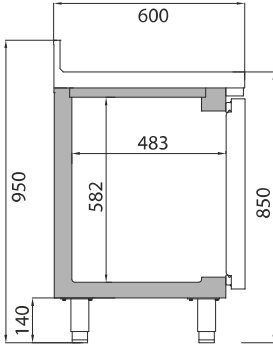

**F= Fregadero / Sin**  
**BMPPF 15**



Opcional  
 Optional  
 Option



**Kit 2 cajones**  
 2 drawers kit  
 Kit 2 tiroirs  
 BM 1/2 x 200

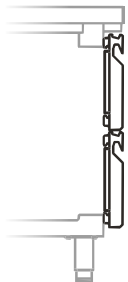

**Kit 2 cajones**  
 2 drawers kit  
 Kit 2 tiroirs  
 BM 2/3x300 +  
 BM 1/3x100

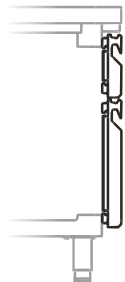

**Kit 3 cajones**  
 3 drawers kit  
 Kit 3 tiroirs  
 BM 1/3x100



1/2                      2/3                      1/3  
**302 x 418 x 205      302 x 418 x 307      302 x 418 x 105**



**KIT CAJONES / DRAWERS KIT / KIT TIROIRS [MOD. CR]**

**Mesa refrigerada pre-instalada /**  
**Remote undercounter refrigerator /**  
**Desserte dessus de comptoir groupe à distance**

**Mesa refrigerada ensaladas /**  
**Salad prep refrigerator undercounter /**  
**Desserte dessus de comptoir posit. prép. salades**

Ensaladas / Salad prep / Prép. salades



MODELO  
 MODELE  
 MODÈLE

**BMPP 1500 GR**

**BMPP 2000 GR**

**BMPP 1500 GRBT**

**BMPP 2000 GRBT**

**BMPP 1500 EN**

**BMPP 2000 EN**

<b>Precio</b> Price Prix							
<b>Medidas</b> Measures (mm) Mesures	↔ ↗ ↕	1240 x 600 x 850 mm.	1732 x 600 x 850 mm.	1240 x 600 x 850 mm.	1732 x 600 x 850 mm.	1468 x 600 x 1100 mm.	1960 x 600 x 1100 mm.
<b>Temperatura</b> Temperature Température	[°C]	<b>0°C/+6°C</b>		<b>-18°C</b>		<b>0°C/+6°C</b>	
<b>Clase Climática</b> Climatic class Classe climatique	[°C]	-				4 / 38°C	
<b>Tensión/Frecuencia</b> Electrical data Tension électrique		230V/1ph/50Hz					
<b>Controlador</b> Controller Régulateur		Digital IP65					
<b>Material</b> Material (EXT/INT) Matériel		AISI 304					
<b>Espesor</b> Thickness Épaisseur	[mm]	70					
<b>Aislamiento</b> Isolation Isolation	[mm]	40kg/m <sup>3</sup> / Free CFC's / Zero ODP-GWP					
<b>Capacidad</b> Capacity Capacité	[L]	250	385	250	385	250+50	385+70
<b>Puertas</b> Doors Portes		2	3	2	3	2	3
<b>Nº parrillas / Guías</b> Nº shelves / Slides Nº de grilles / Glissière		2/2 [325x430]	3/3 [325x430]	2/2 [325x430]	3/3 [325x430]	2/2 [325x430]	3/3 [325x430]
<b>Sistema de frío</b> Cooling System Système de froid		Monoblock ventilado / Forced air monoblock / Monoblock ventilé					
<b>Desescarche</b> Defrost Dégivrage		Parada compresor / Compressor off / Arrêt du compresseur		Gas caliente / Hot gas / Gaz chaud		Parada compresor / Compressor off / Arrêt du compresseur	
<b>Expansión</b> Expansion Expansion		Opcional / Optional / Options				Capilar / Capillary / Capillaire	
<b>Potencia</b> Power Puissance	[W]	-				249	249
<b>Potencia frig.</b> Cooling capacity Puissance Frig.	[W A -10/-30°C]	Recom. 370	Recom. 370	Recom. 445	Recom. 445	370	370
<b>Consumo</b> Consumption Consommation	[kWh/ 24h]	-					
<b>Clase energética</b> Energy class Classe Énerg.		-					
<b>Refrigerante</b> Refrigerant Gaz		-				<b>R-290</b>	
<b>Opcional</b> Optional Options		Juego de guías / Slides / Jeu de Glissières [GUIAC0115430, GUIAC0215430] Cerradura / Lock / Serrure [506X209; 506X210] Parrilla / Wire shelf / Grille [502X07]					
		Válvula expansión [especificar refrigerante] / Expansion valve [specify refrigerant] / Détendeur [spécifier le gaz] Puerta de cristal [unidad] / Glass door [unit] / Porte vitrée [unité] [PUE17IDGN-PUE17IIGN][GR]				Ruedas / Casters / Roulettes [705X16=2; 705X17=2] BMPP 1500 EN [501X16] = 8 BMPP 2000 EN [501X16] = 11	
		Kit cajones / Drawer Kit / Kit tiroirs BM 1/2 x 200 [JCAJ17BM1/2] BM 1/3 x 100 [JCAJ17BM1/3] BM 2/3 + BM 1/3 [JCAJ17BM2/3]		Kit cajones / Drawer Kit / Kit tiroirs Consultar / On request / À la demande 115V/1ph/60Hz 230V/1ph/60Hz		Kit cajones / Drawer Kit / Kit tiroirs BM 1/2 x 200 [JCAJ17BM1/2] BM 1/3 x 100 [JCAJ17BM1/3] BM 2/3 + BM 1/3 [JCAJ17BM2/3]	

Serie / Series / Série **600**

+Info: [www.infrico.com](http://www.infrico.com)

**Video del producto**

Product Video  
Vidéo du produit



Infrico Youtube

Refuerzo con Omegas.  
Omega reinforcement.  
Renforcement avec Omegas.



**Posibilidad de acceso frontal y lateral para una mejor manipulación.**

Front and lateral access for better handling  
Possibilité d'accès frontal et latéral pour une meilleure manipulation.



Refrigeración estática en la cuba  
Static cooling in the tank  
Refroidissement statique supérieur



BMPP 2000 EN

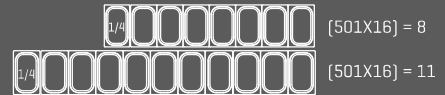

Kit 2 cajones  
2 drawers kit  
Kit 2 tiroirs

BM 1/2 x 200



Kit 2 cajones  
2 drawers kit  
Kit 2 tiroirs

BM 2/3x300 +  
BM 1/3x100



Kit 3 cajones  
3 drawers kit  
Kit 3 tiroirs

BM 1/3x100



1/2  
302 x 418 x 205

2/3  
302 x 418 x 307

1/3  
302 x 418 x 105











**KIT CAJONES / DRAWERS KIT / KIT TIROIRS [MOD. GR - EN]**



## Mesa baja refrigeración y congelación / Counter bases refrigerator and freezer/ Soubassement gastronomique positif et negative

2

MODELO MODELE MODÈLE									
<b>Precio</b> Price Prix									
<b>Medidas</b> Measures (mm) Mesures	1000 x 700 x 650 mm.	1400 x 700 x 650 mm.	1600 x 700 x 650 mm.	2000 x 700 x 650 mm.	2400 x 700 x 650 mm.	1000 x 700 x 650 mm.	1400 x 700 x 650 mm.	1600 x 700 x 650 mm.	2000 x 700 x 650 mm.
<b>Temperatura</b> Temperature Température	-2°C/+8°C					-18°C			
<b>Clase Climática</b> Climatic class Classe climatique	5 / 40°C					4 / 38°C			
<b>Tensión/Frecuencia</b> Electrical data Tension électrique	230V/1ph/50Hz								
<b>Controlador</b> Controller Régulateur	Digital IP65								
<b>Material</b> Material (EXT/INT) Matériel	AISI 304								
<b>Espesor</b> Thickness Épaisseur	70								
<b>Aislamiento</b> Isolation Isolation	40kg/m <sup>3</sup> / Free CFC's / Zero ODP-GWP								
<b>Capacidad</b> Capacity Capacité	100	190	225	310	435	100	190	225	310
<b>Cajones</b> Drawers Tiroirs	2	4	4	6	8	2	4	4	6
<b>N° parrillas / Guías</b> N° shelves / Slides N° de grilles / Glissière	-								
<b>Sistema de frío</b> Cooling System Système de froid	Monoblock ventilado / Forced air monoblock / Monoblock ventilé								
<b>Desescarche</b> Defrost Dégivrage	Parada compresor / Compressor off / Arrêt du compresseur					Gas caliente / Hot gas defrost / Gaz chaud			
<b>Expansión</b> Expansion Expansion	Capilar / Capillary / Capillaire					Válvula de expansión termostática / Thermostatic expansion valve / Détendeur thermostatique			
<b>Potencia</b> Power Puissance	205	210			368	443	443	472	561
<b>Potencia frig.</b> Cooling capacity Puissance Frig.	370				690	445	445	540	540
<b>Consumo</b> Consumption Consommation	0,98	1,23	1,33	1,61	1,77	4,02	4,02	6,57	6,78
<b>Clase energética</b> Energy class Classe Énerg.	<b>A</b>	<b>A</b>	<b>A</b>	<b>B</b>	<b>B</b>	<b>C</b>	<b>C</b>	<b>D</b>	<b>D</b>
<b>Refrigerante</b> Refrigerant Gaz	<b>R-290</b>								
<b>Opcional</b> Optional Options	Cerradura / Lock / Serrure [506X209; 506X210] Puerta [unidad] / Door [unit] / Porte [unité] [PUE17ISN] Cajón / Drawer / Tiroir 2/3x300 [JCAJ17SN2/3] <b>Sin incremento / Without supplement / Sans supplément</b>								
	115V/1ph/60Hz 230V/1ph/60Hz					115V/1ph/60Hz 230V/1ph/60Hz			

**NEW**

Serie / Series / Série **MSG GN1/1 700**

+Info: [www.infrico.com](http://www.infrico.com)

### MSG 2000



Refuerzo con Omegas.  
Omega reinforcement.  
Renforcement avec Omegas.



Controlador digital IP 65.  
Digital control IP65  
Contrôleur digital IP 65.



Opcional: Manejo control digital por WiFi o Bluetooth®

Optional: Operating digital control by WiFi or Bluetooth®

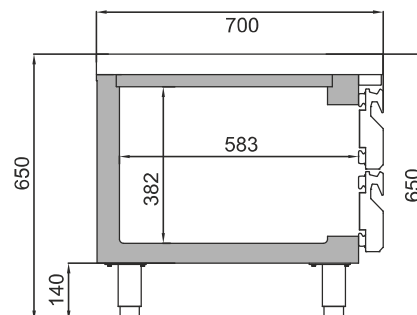

### MSG 1600



Puertas opcionales  
Optionals doors  
Portes en option

## Mesa refrigeración y congelación / Undercounter refrigerator and freezer / Desserte gastronomique positive et négative

2

MODELO  
MODELE  
MODÈLE



**BMGN 1470 II**

**BMGN 1960 II**

**BMGN 2450 II**

**BMGN 1470 BT**

**BMGN 1960 BT**

**BMGN 2450 BT**

<b>Precio</b> Price Prix							
<b>Medidas</b> Measures (mm) Mesures	↔ ↕	1468 x 700 x 850 mm.	1960 x 700 x 850 mm.	2452 x 700 x 850 mm.	1468 x 700 x 850 mm.	1960 x 700 x 850 mm.	2452 x 700 x 850 mm.
<b>Temperatura</b> Temperature Température	[°C]	-2°C/+8°C			-18°C		
<b>Clase Climática</b> Climatic class Classe climatique	[°C]	5 / 40°C			4 / 38°C		
<b>Tensión/Frecuencia</b> Electrical data Tension électrique		230V/1ph/50Hz					
<b>Controlador</b> Controller Régulateur		Digital IP65					
<b>Material</b> Material (EXT/INT) Matériel		AISI 304					
<b>Espesor</b> Thickness Épaisseur	[mm]	70					
<b>Aislamiento</b> Isolation Isolation	[mm]	40kg/m <sup>3</sup> / Free CFC's / Zero ODP-GWP					
<b>Capacidad</b> Capacity Capacité	[L]	305	465	630	305	465	630
<b>Puertas</b> Doors Portes		2	3	4	2	3	4
<b>N° parrillas / Guías</b> N° shelves / Slides N° de grilles / Glissière		2/10 [325x530]	3/15 [325x530]	4/20 [325x530]	2/10 [325x530]	3/15 [325x530]	4/20 [325x530]
<b>Sistema de frío</b> Cooling System Système de froid		Monoblock ventilado / Forced air monoblock / Monoblock ventilé					
<b>Desescarche</b> Defrost Dégivrage		Parada compresor / Compressor off / Arrêt du compresseur			Gas caliente / Hot gas defrost / Gaz chaud		
<b>Expansión</b> Expansion Expansion		Capilar / Capillary / Capillaire			Válvula de expansión termostática / Thermostatic expansion valve / Détendeur thermostatique		
<b>Potencia</b> Power Puissance	[W]	210	368	508	597	711	
<b>Potencia frig.</b> Cooling capacity Puissance Frig.	[W A -10°C]	570	690	445	540	640	
<b>Consumo</b> Consumption Consommation	[kWh/ 24h]	1,50	1,95	2,25	5,45	7,71	9,03
<b>Clase energética</b> Energy class Classe Énerg.		<b>A</b>			<b>C</b>	<b>D</b>	<b>D</b>
<b>Refrigerante</b> Refrigerant Gaz		<b>R-290</b>					
<b>Opcional</b> Optional Options		Sin peto trasero / Without backslash / Sans dossieret Parrilla / Wire shelf / Grille [502X12] Juego de guías / Slides / Jeu de Glissières [GUIAC0115530, GUIAC0215530] Cerradura / Lock / Serrure [506X209; 506X210]			Ruedas / Casters / Roulettes [705X16=2; 705X17=2]		
		Kit cajones / Drawer Kit / Kit tiroirs BMGN 1/2 x 200 [JCAJ17GN1/2] BMGN 1/3 x 100 [JCAJ17GN1/3] BMGN 2/3 + BMGN 1/3 [JCAJ17GN2/3]			115V/1ph/60Hz 230V/1ph/60Hz		

Serie / Series / Série **GN1/1 700**

+Info: [www.infrico.com](http://www.infrico.com)

**BMGN 1470 II**

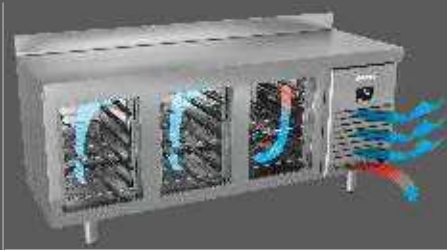

Refuerzo con Omegas.  
Omega reinforcement.  
Renforcement avec Omegas.

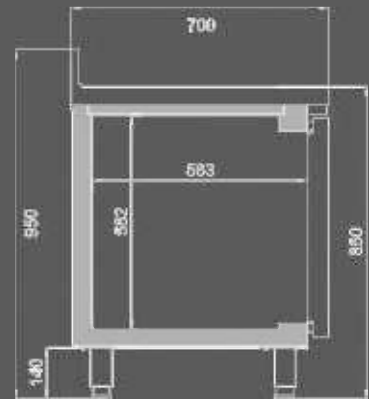

**Kit 2 cajones**  
2 drawers kit  
Kit 2 tiroirs  
BM 1/2 x 200



**Kit 2 cajones**  
2 drawers kit  
Kit 2 tiroirs  
BM 2/3x300 +  
BM 1/3x100



**Kit 3 cajones**  
3 drawers kit  
Kit 3 tiroirs  
BM 1/3x100



**1/2 302 x 518 x 205**      **2/3 302 x 518 x 307**      **1/3 302 x 518 x 105**



**KIT CAJONES / DRAWERS KIT / KIT TIROIRS (MOD. II)**

## Mesa refrigeración y congelación / Undercounter refrigerator and freezer / Desserte gastronomique positive et négative

MODELO  
MODELE  
MODÈLE



	BMGN 1470 A+	BMGN 1960 A+
<b>Precio</b> Price Prix		
<b>Medidas</b> Measures Mesures (mm)	1468 x 700 x 850 mm.	1960 x 700 x 850 mm.
<b>Temperatura</b> Temperature Température (°C)	-2°C/+8°C	
<b>Clase Climática</b> Climatic class Classe climatique (°C)	5 / 40°C	
<b>Tensión/Frecuencia</b> Electrical data Tension électrique	230V/1ph/50Hz	
<b>Controlador</b> Controller Régulateur	Digital IP65	
<b>Material</b> Material Matériel (EXT/INT)	AISI 304	
<b>Espesor</b> Thickness Épaisseur (mm)	70	
<b>Aislamiento</b> Isolation Isolation (mm)	40kg/m <sup>3</sup> / Free CFC's / Zero ODP-GWP	
<b>Capacidad</b> Capacity Capacité (L)	305	465
<b>Puertas</b> Doors Portes	2	3
<b>N° parrillas / Guías</b> N° shelves / Slides N° de grilles / Glissière	2/10 [325x530]	3/15 [325x530]
<b>Sistema de frío</b> Cooling System Système de froid	Monoblock ventilado / Forced air monoblock / Monoblock ventilé	
<b>Desescarche</b> Defrost Dégivrage	Parada compresor / Compressor off / Arrêt du compresseur	
<b>Expansión</b> Expansion Expansion	Capilar / Capillary / Capillaire	
<b>Potencia</b> Power Puissance (W)	210	368
<b>Potencia frig.</b> Cooling capacity Puissance Frig. (W A -10°C)	570	690
<b>Consumo</b> Consumption Consommation (kWh/ 24h)	0,82	1,01
<b>Clase energética</b> Energy class Classe Énerg.	A+	
<b>Refrigerante</b> Refrigerant Gaz	R-290	
<b>Opcional</b> Optional Options	Sin peto trasero / Without backslash / Sans dossieret Parrilla / Wire shelf / Grille [502X12] Juego de guías / Slides / Jeu de Glissières [GUIAC0115530, GUIAC0215530] Cerradura / Lock / Serrure [506X209; 506X210] Grupo lado contrario / Group opposite side / Groupe opposé [L] 115V/1ph/60Hz 230V/1ph/60Hz Ruedas / Casters / Roulettes [705X16=2; 705X17=2]	

**NEW**

Serie / Series / Série **GN1/1 700**

+Info: [www.infrico.com](http://www.infrico.com)

Clase energ.  
Energy class  
Classe Énerg.

# A+

## INVERTER

BMGN 1960 A+



Refuerzo con Omegas.  
Omega reinforcement.  
Renforcement avec Omegas.







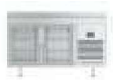

**Mesa refrigerada puertas cristal /**  
**Glass Door undercounter refrigerator /**  
 Desserte dessus de comptoir posit. portes vitrées

**Mesa refrigerada con fregadero /**  
**Sink undercounter refrigerator /**  
 Desserte dessus de comptoir posit. avec évier



F= Fregadero / Sink / Evier

MODELO MODELE MODÈLE						
	BMGN 1470 CR	BMGN 1960 CR	BMGN 2450 CR	BMGN 1470 F	BMGN 1960 F	BMGN 2450 F
<b>Precio</b> Price Prix						
<b>Medidas</b> Measures (mm) Mesures	1468 x 700 x 850 mm.	1960 x 700 x 850 mm.	2452 x 700 x 850 mm.	1468 x 700 x 850 mm.	1960 x 700 x 850 mm.	2452 x 700 x 850 mm.
<b>Temperatura</b> Temperature Température		+2°C/+6°C		-2°C/+8°C		
<b>Clase Climática</b> Climatic class Classe climatique		4 / 38°C		5 / 40°C		
<b>Tensión/Frecuencia</b> Electrical data Tension électrique	230V/1ph/50Hz					
<b>Controlador</b> Controller Régulateur	Digital IP65					
<b>Material</b> Material (EXT/INT) Matériel	AISI 304					
<b>Espesor</b> Thickness Épaisseur	70					
<b>Aislamiento</b> Isolation Isolation	40kg/m <sup>3</sup> / Free CFC's / Zero ODP-GWP					
<b>Capacidad</b> Capacity Capacité	305	465	630	305	465	630
<b>Puertas</b> Doors Portes	2	3	4	2	3	4
<b>N° parrillas / Guías</b> N° shelves / Slides N° de grilles / Glissière	2/10 {325x530}	3/15 {325x530}	4/20 {325x530}	2/10 {325x530}	3/15 {325x530}	4/20 {325x530}
<b>Sistema de frío</b> Cooling System Système de froid	Monoblock ventilado / Forced air monoblock / Monoblock ventilé					
<b>Desescarche</b> Defrost Dégivrage	Parada compresor / Compressor off / Arrêt du compresseur					
<b>Expansión</b> Expansion Expansion	Capilar / Capillary / Capillaire					
<b>Potencia</b> Power Puissance	377	382	387	210	368	
<b>Potencia frig.</b> Cooling capacity Puissance Frig.	690	690	690	370	690	
<b>Consumo</b> Consumption Consommation		-		1,50	1,95	2,25
<b>Clase energética</b> Energy class Classe Énerg.		-		<b>A</b>	<b>A</b>	<b>A</b>
<b>Refrigerante</b> Refrigerant Gaz	<b>R-290</b>					
<b>Opcional</b> Optional Options	Juego de guías / Slides / Jeu de Glissières (GUIAC0115530, GUIAC0215530)			Parrilla / Wire shelf / Grille (502X12) Cerradura / Lock / Serrure (506X209; 506X210) Grupo lado contrario / Group opposite side / Groupe opposé (L) Kit cajones / Drawer Kit / Kit tiroirs BMGN 1/2 x 200 (JCAJ176N1/2) BMGN 1/3 x 100 (JCAJ176N1/3) BMGN 2/3 + BMGN 1/3 (JCAJ176N2/3)		

Serie / Series / Série **GN1/1 700**

+Info: [www.infrico.com](http://www.infrico.com)



F= Fregadero  
BMGN F

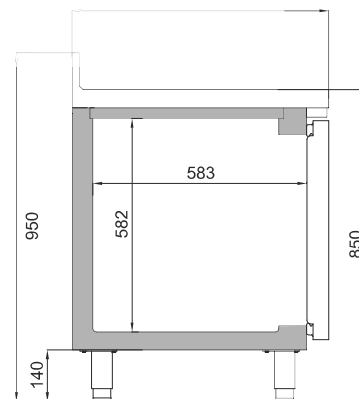
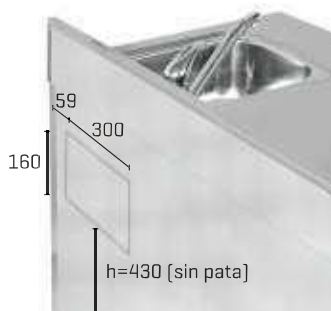

Kit 2 cajones  
2 drawers kit  
Kit 2 tiroirs

BM 1/2 x 200



Kit 2 cajones  
2 drawers kit  
Kit 2 tiroirs

BM 2/3x300 +  
BM 1/3x100



Kit 3 cajones  
3 drawers kit  
Kit 3 tiroirs

BM 1/3x100



1/2                      2/3                      1/3  
**302 x 518 x 205      302 x 518 x 307      302 x 518 x 105**



**KIT CAJONES / DRAWERS KIT / KIT TIROIRS (MOD. F)**



**Mesa refrigerada pre-instalada /**  
**Remote undercounter refrigerator /**  
**Desserte dessus de comptoir groupe á distance**

**Mesa refrigerada central puertas a dos caras /**  
**Pass thru undercounter refrigerator /**  
**Desserte gastronomique positive traversante**



Dos caras / Pass-thru / Traversante

MODELO  
 MODELE  
 MODÈLE



	BMGN 1470 GR	BMGN 1960 GR	BMGN 2450 GR	BMGN 1470 GRBT	BMGN 1960 GRBT	BMGN 2450 GRBT	BMGN 1470 PDC	BMGN 1960 PDC
<b>Precio</b> Price Prix	<b>2.074 €</b>	<b>2.492 €</b>	<b>2.985 €</b>	<b>2.269 €</b>	<b>2.687 €</b>	<b>3.180 €</b>	<b>3.191 €</b>	<b>3.724 €</b>
<b>Medidas</b> Measures (mm) Mesures	1240 x 700 x 850 mm.	1732 x 700 x 850 mm.	2224 x 700 x 850 mm.	1240 x 700 x 850 mm.	1732 x 700 x 850 mm.	2224 x 700 x 850 mm.	1468 x 700 x 850 mm.	1960 x 700 x 850 mm.
<b>Temperatura</b> Temperature Température	<b>-2°C/+8°C</b>			<b>-18°C</b>			<b>-2°C/+8°C</b>	
<b>Clase Climática</b> Climatic class Classe climatique	-			-			5 / 40°C	
<b>Tensión/Frecuencia</b> Electrical data Tension électrique	230V/1ph/50Hz							
<b>Controlador</b> Controller Régulateur	Digital IP65							
<b>Material</b> Material (EXT/INT) Matériel	Inox AISI 304							
<b>Espesor</b> Thickness Épaisseur	70							
<b>Aislamiento</b> Isolation Isolation	40kg/m <sup>3</sup> / Free CFC's / Zero ODP-GWP							
<b>Capacidad</b> Capacity Capacité	305	465	630	305	465	630	290	440
<b>Puertas</b> Doors Portes	2	3	4	2	3	4	4	6
<b>N° parrillas / Guías</b> N° shelves / Slides N° de grilles / Glissière	2/10 (325x530)	3/15 (325x530)	4/20 (325x530)	2/10 (325x530)	3/15 (325x530)	4/20 (325x530)	2/10 (325x530)	3/15 (325x530)
<b>Sistema de frío</b> Cooling System Système de froid	-						Monoblock ventilado / Forced air monoblock / Monoblock ventilé	
<b>Desescarche</b> Defrost Dégivrage	Parada compresor / Compressor off / Arrêt du compresseur			Gas caliente / Hot gas / Gaz chaud			Parada compresor / Compressor off / Arrêt du compresseur	
<b>Expansión</b> Expansion Expansion	-			-			Capilar / Capillary / Capillaire	
<b>Potencia</b> Power Puissance	-			-			210	368
<b>Potencia frig.</b> Cooling capacity Puissance Frig. (W/A -10/+30°C)	343	690	690	445	540	640	370	690
<b>Consumo</b> Consumption Consommation (kWh/ 24h)	-			-			1,50	1,95
<b>Clase energética</b> Energy class Classe Énerg.	-			-			<b>A</b>	<b>A</b>
<b>Refrigerante</b> Refrigerant Gaz	-						<b>R-290</b>	
<b>Opcional</b> Optional Options	Puerta de cristal / Glass door / Porte vitrée [PUE17IDGN-PUE17IIGN]						<b>122 €</b>	
	Cerradura / Lock / Serrure [506X209; 506X210]						<b>44 €</b>	
	Parrilla / Wire shelf / Grille [502X12]						<b>45 €</b>	
	Kit cajones / Drawer Kit / Kit tiroirs BMGN 1/2 x 200 [JCAJ17GN1/2]		<b>643 €</b>		Kit cajones / Drawer Kit / Kit tiroirs Consultar / On request / À la demande		Juego de guías / Slides / Jeu de Glissières	
BMGN 1/3 x 100 [JCAJ17GN1/3]		<b>954 €</b>		115V/1ph/60Hz <b>+ 3%</b>		[GUIACO3505] <b>38 €</b>		
BMGN 2/3 + BMGN 1/3 [JCAJ17GN2/3]		<b>711 €</b>		230V/1ph/60Hz <b>Sin incremento / No increase / Sans supplément</b>				
Válvula de expansión (especificar refrigerante) Expansion valve (specify refrigerant) Détendeur d'expansion (spécifier le gaz souhaité)						Parrilla inoxidable / Stainless steel wire shelf / Grille Inox		
Juego de guías / Slides / Jeu de Glissières [GUIACO115530, GUIACO215530]						<b>38 €</b>		
						<b>76 €</b>		

Serie / Series / Série **GN1/1 700**

+Info: [www.infrico.com](http://www.infrico.com)



**Posibilidad de acceso frontal y lateral para una mejor manipulación**

Front and lateral access for better handling

Possibilité d'accès frontal et latéral pour une meilleure manipulation.

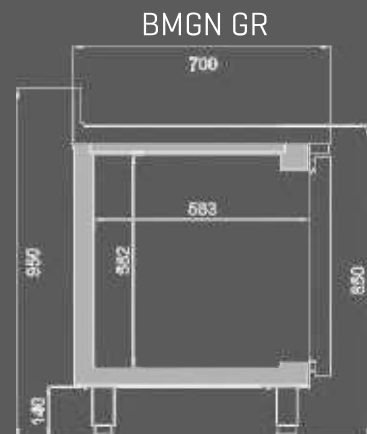
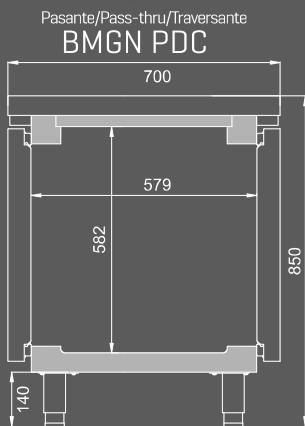

**Kit 2 cajones**  
2 drawers kit  
Kit 2 tiroirs

BM 1/2 x 200



**Kit 2 cajones**  
2 drawers kit  
Kit 2 tiroirs

BM 2/3x300 +  
BM 1/3x100



**Kit 3 cajones**  
3 drawers kit  
Kit 3 tiroirs

BM 1/3x100

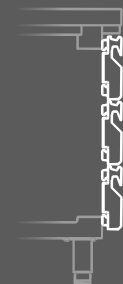

1/2  
**302 x 518 x 205**

2/3  
**302 x 518 x 307**

1/3  
**302 x 518 x 105**



**KIT CAJONES / DRAWERS KIT / KIT TIROIRS (MOD. GR)**

**Mesa refrigerada ensaladas /**  
**Salad prep refrigerator table /**  
 Desserte gastronomique positive préparation salades

**Mesa refrigerada pizza /**  
**Pizza undercounter refrigerator /**  
 Desserte gastronomique positive préparation pizza

MODELO  
 MODÈLE  
 MODÈLE

Ensalada / Salad / Salade



**BMGN 1470 EN**



**BMGN 1960 EN**



**MPG 1490**

Pizza / Pizza / Pizza



**MPG 1980**



**ME 1003 VIP**

Precio Price Prix						
Medidas Measures (mm) Mesures	↔ ↗ ↕	1468 x 700 x 850/1100 mm.	1960 x 700 x 850/1100 mm.	1490 x 700 x 830/1417 mm.	1980 x 700 x 830/1417 mm.	1490 x 700 x 885/1417 mm.
Temperatura Temperature Température	[°C]	0°/+6°C.			0°C/+6°C. +4°C/+8°C.	
Clase Climática Climatic class Classe climatique	[°C]	4 / 38°C				
Tensión/Frecuencia Electrical data Tension électrique		230V/1ph/50Hz				
Controlador Controller Régulateur		Digital IP65				
Material Material (EXT/INT) Matériel		Inox AISI 304				
Espesor Thickness Épaisseur	[mm]	70				
Aislamiento Isolation Isolation	[mm]	40kg/m <sup>3</sup> / Free CFC's / Zero ODP-GWP				
Capacidad Capacity Capacité	[L]	305+65	465+85	305+35	465+54	355+35
Puertas Doors Portes		2	3	2	3	3
N° parrillas / Guías N° shelves / Slides N° de grilles / Glissière		2/10 [325x530]	3/15 [325x530]	2/10 [325x530]	3/15 [325x530]	3/9 [325x530]
Sistema de frío Cooling System Système de froid		Monoblock ventilado / Forced air monoblock / Monoblock ventilé				
Desescarche Defrost Dégivrage		Parada compresor / Compressor off / Arrêt du compresseur				
Expansión Expansion Expansion		Capilar / Capillary / Capillaire				
Potencia Power Puissance	[W]	210	368	369	553	503
Potencia frig. Cooling capacity Puissance Frig.	[W A -10°C]	370	690	370+170	690+170	690+170
Consumo Consumption Consommation	[kWh/ 24h]	-	-	-	-	-
Clase energética Energy class Classe Énerg.		-	-	-	-	-
Refrigerante Refrigerant Gaz		<b>R-290</b>				
Opcional Optional Options		Parrilla / Wire shelf / Grille [502X12] Juego de guías / Slides / Jeu de Glissières [GUIAC0115530, GUIAC0215530] Cerradura / Lock / Serrure [506X209; 506X210] 230V/1ph/60Hz 115V/1ph/60Hz				
		{501X13} = 1 {501X11} = 6 {501X13} = 1 {501X11} = 9		{501X16} = 6 {501X13} = 1 {501X16} = 7		{501X16} = 6
		Ruedas / Casters / Roulettes [705X16=2; 705X17=2]				

Serie / Series / Série **GN1/1 700**

+Info: [www.infrico.com](http://www.infrico.com)

**IMPORTANTE:** Las bandejas deben contener producto previamente refrigerado.  
**IMPORTANT:** The trays should contain previously refrigerated product.  
**IMPORTANT:** Les plateaux doivent contenir des produits préalablement réfrigérés.

**Refrigeración estática en la cuba**  
 Static cooling in the tank  
 Refroidissement statique supérieur

BMGN 1960 EN



**Granito**  
 Granite worktop  
 Granit

**Granito**  
 Granite worktop  
 Granit



MPG 1980



ME 1003 VIP

[501X16] = 6



[501X13] = 1 [501X16] = 7



[501X13] = 1 [501X11] = 6



[501X13] = 1 [501X11] = 9

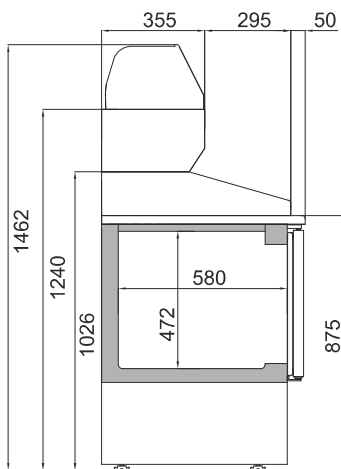

ME VIP

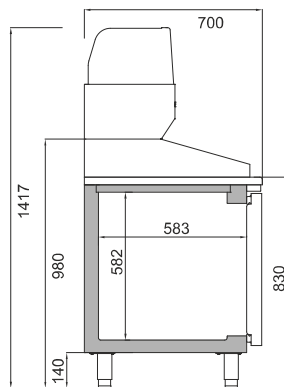



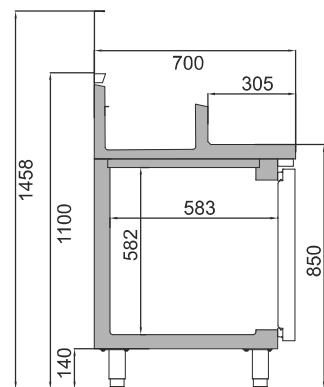

MPG



BMGN EN

## Mesa refrigerada ensaladas / Salad prep refrigerator table / Desserte gastronomique positive préparation salades

2

MODELO MODELE MODÈLE					
<b>Precio</b> Price Prix					
<b>Medidas</b> Measures (mm) Mesures	978 x 700 x 890 mm.	978 x 700 x 895/1050 mm.	978 x 700 x 895 mm.	978 x 700 x 875/1140 mm.	978 x 700 x 865/1125 mm.
<b>Temperatura</b> Temperature Température	0°C/+6°C.				
<b>Clase Climática</b> Climatic class Classe climatique	4 / 38°C				
<b>Tensión/Frecuencia</b> Electrical data Tension électrique	230V/1ph/50Hz				
<b>Controlador</b> Controller Régulateur	Digital IP65				
<b>Material</b> Material (EXT/INT) Matériel	Inox AISI 304				
<b>Espesor</b> Thickness Épaisseur	55				
<b>Aislamiento</b> Isolation Isolation	40kg/m <sup>3</sup> / Free CFC's / Zero ODP-GWP				
<b>Capacidad</b> Capacity Capacité	230				
<b>Puertas</b> Doors Portes	2				
<b>N° parrillas / Guías</b> N° shelves / Slides N° de grilles / Glissière	2/6 (325x530)				
<b>Sistema de frío</b> Cooling System Système de froid	Ventilado / Forced air / Ventilé				
<b>Desescarche</b> Defrost Dégivrage	Parada compresor / Compressor off / Arrêt du compresseur				
<b>Expansión</b> Expansion Expansion	Capilar / Capillary / Capillaire				
<b>Potencia</b> Power Puissance	210				
<b>Potencia frig.</b> Cooling capacity Puissance Frig.	370				
<b>Consumo</b> Consumption Consommation	-				
<b>Clase energética</b> Energy class Classe Énerg.	-				
<b>Refrigerante</b> Refrigerant Gaz	R-290				
<b>Opcional</b> Optional Options	Juego de guías / Slides / Jeu de Glissières [GUIAC0115530; GUIAC0215530] Kit 2 cajones 1x1/2 + 1x1/3 [Modelo II] / Drawers kit 1x1/2 + 1x1/3 [Model II] Kit tiroirs 1x1/2 + 1x1/3 [Modèle II] [JCAJ17ME1/2] Puerta de cristal / Glass door / Porte vitrée [PUE17IDME10-PUE17IIME10]			Parrilla / Wire shelf / Grille [502X12] Cerradura / Lock / Serrure [506X120; 506X121]	
	[501X11] = 6 [501X10] = 3	[501X16] = 5	-	[501X11] = 3 [501X10] = 1	[501X11] = 6 [501X10] = 3

Serie / Series / Série **GN1/1 700**

+Info: [www.infrico.com](http://www.infrico.com)



[501X11] = 6 [501X10] = 3

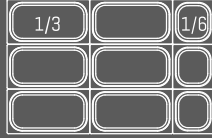

ME 1000 BAN



Optional: Manejo control digital por WiFi o Bluetooth®  
Optional: Operating digital control by WiFi or Bluetooth®



[501X16] = 5



ME 1000 EN

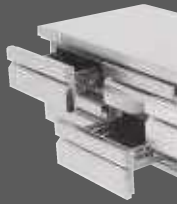

Kit 2 cajones 1x1/2 + 1x1/3 (Modelo II) /  
Drawers kit 1x1/2 + 1x1/3 (Model II)  
Kit tiroirs 1x1/2 + 1x1/3 (Modèle II)  
{JCAJ17ME1/2}

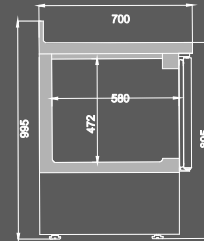

ME 1000 II



[501X11] = 3 [501X10] = 1



ME 1000 PIZZA



[501X11] = 6 [501X10] = 3

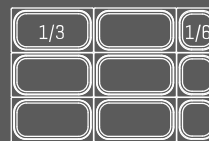





ME 1000 KB



## Mesa refrigerada ensaladas / Salad prep refrigerator table / Desserte gastronomique positive préparation salades

2

MODELO MODELE MODÈLE					
<b>Precio</b> Price Prix					
<b>Medidas</b> Measures (mm) Mesures	1460 x 700 x 890 mm.	1460 x 700 x 885/1050 mm.	1460 x 700 x 895 mm.	1460 x 700 x 875/1140 mm.	1460 x 700 x 865/1125 mm.
<b>Temperatura</b> Temperature Température	0°C/+6°C.				
<b>Clase Climática</b> Climatic class Classe climatique	4 / 38°C				
<b>Tensión/Frecuencia</b> Electrical data Tension électrique	230V/1ph/50Hz				
<b>Controlador</b> Controller Régulateur	Digital IP65				
<b>Material</b> Material (EXT/INT) Matériel	Inox AISI 304				
<b>Espesor</b> Thickness Épaisseur	40kg/m <sup>3</sup> / Free CFC's / Zero ODP-GWP				
<b>Aislamiento</b> Isolation Isolation	55				
<b>Capacidad</b> Capacity Capacité	355				
<b>Puertas</b> Doors Portes	3				
<b>N° parrillas / Guías</b> N° shelves / Slides N° de grilles / Glissière	3/9 (325x530)				
<b>Sistema de frío</b> Cooling System Système de froid	Ventilado / Forced air / Ventilé				
<b>Desescarche</b> Defrost Dégivrage	Parada compresor / Compressor off / Arrêt du compresseur				
<b>Expansión</b> Expansion Expansion	Capilar / Capillary / Capillaire				
<b>Potencia</b> Power Puissance	368				
<b>Potencia frig.</b> Cooling capacity Puissance Frig.	690				
<b>Consumo</b> Consumption Consommation	-				
<b>Clase energética</b> Energy class Classe Énerg.	-				
<b>Refrigerante</b> Refrigerant Gaz	R-290				
<b>Opcional</b> Optional Options	Juego de guías / Slides / Jeu de Glissières (GUIACO115530; GUIACO215530) Kit 2 cajones 1x1/2 + 1x1/3 (Modelo II) / Drawers kit 1x1/2 + 1x1/3 (Model II) Kit tiroirs 1x1/2 + 1x1/3 (Modèle II) (JCAJ17ME1/2) Puerta de cristal / Glass door / Porte vitrée (PUE17IDME10-PUE17IIME10)			Parrilla / Wire shelf / Grille (502X12) Cerradura / Lock / Serrure (506X120; 506X121)	
	{501X11} = 9 {501X10} = 6	{501X16} = 8	-	{501X11} = 2 {501X10} = 4	{501X11} = 9 {501X10} = 6

Serie / Series / Série **GN1/1 700**

+Info: [www.infrico.com](http://www.infrico.com)



[501X11] = 9 [501X10] = 6

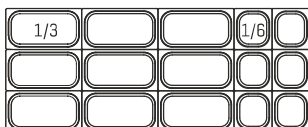

ME 1003 BAN

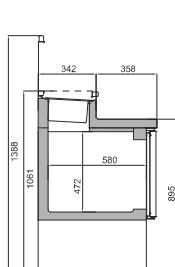

[501X16] = 8



ME 1003 EN



Kit 2 cajones 1x1/2 + 1x1/3 (Modelo II) /  
 Drawers kit 1x1/2 + 1x1/3 (Model II)  
 Kit tiroirs 1x1/2 + 1x1/3 (Modèle II)  
 [JCAJ17ME1/2]

1000 II

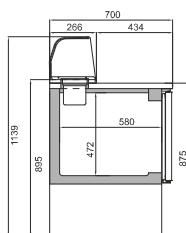

[501X11] = 2 [501X10] = 4



ME 1003 PIZZA



[501X11] = 9 [501X10] = 6

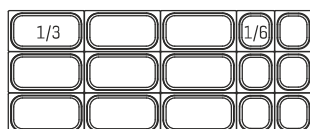





ME 1003 KB





## Mesa refrigerada cocktails / Cocktails refrigerator table / Desserte gastronomique positive préparation cocktails

2

MODELO MODELE MODÈLE					
	BST 1600 R	BST 2000 R	BST 1200 N	BST 1600 N	BST 2000 N
<b>Precio</b> Price Prix					
<b>Medidas</b> Measures (mm) Mesures	1600 x 700 x 1059 mm.	2000 x 700 x 1059 mm.	1200 x 600 x 944 mm.	1600 x 600 x 944 mm.	2000 x 600 x 944 mm.
<b>Temperatura</b> Temperature Température	-2°C/+8°C.		-		
<b>Clase Climática</b> Climatic class Classe climatique	4 / 38°C		-		
<b>Tensión/Frecuencia</b> Electrical data Tension électrique	230V/1ph/50Hz		-		
<b>Controlador</b> Controller Régulateur	Digital IP65		-		
<b>Material</b> Material (EXT/INT) Matériel	Inox AISI 304				
<b>Aislamiento</b> Isolation (mm) Isolation	40kg/m <sup>3</sup> / Free CFC's / Zero ODP-GWP				
<b>Cuba para hielo</b> Ice tank Bac à glace	Inyectada y refrigerada Injected and refrigerated Injecté et réfrigéré		Inyectada / Injected / Injecté		
<b>Capacidad Snack</b> Capacity Snack Capacité Snack	255	310	-	-	-
<b>Cajones</b> Drawers Tiroirs	4	6	-	-	-
<b>Enchufe accesorios</b> Accessories Plug Prise pour accessoires	Sí / Yes / Oui		-		
<b>Sistema de frío</b> Cooling System Système de froid	Ventilado / Forced air / Ventilé		-		
<b>Desescarche</b> Defrost Dégivrage	Parada compresor / Compressor off / Arrêt du compresseur		-		
<b>Expansión</b> Expansion Expansion	Capilar / Capillary / Capillaire		-		
<b>Potencia</b> Power Puissance	210	368	-		
<b>Potencia frig.</b> Cooling capacity Puissance Frig.	370	690	-		
<b>Consumo</b> Consumption Consommation	1.61	1.77	-		
<b>Clase energética</b> Energy class Classe Énerg.	-				
<b>Refrigerante</b> Refrigerant Gaz	R-290		-		
<b>Opcional</b> Optional Options	Cerradura / Lock / Serrure (506X209; 506X210) Puerta (unidad) / Door (unit) / Porte (unité) (PUE17ISN) Ruedas / Casters / Roulettes Cubetas 1/9 / Bacs 1/9 / Cuves 1/9 Doble carril de botellas / Double speed rack / Double rail à bouteilles  115V/1ph/60Hz 230V/1ph/60Hz		Ruedas / Casters / Roulettes  Cubetas 1/9 / Bacs 1/9 / Cuves 1/9  Doble carril de botellas / Double bottle lane / Double rail à bouteilles	Ruedas / Casters / Roulettes  Cubetas 1/9 / Bacs 1/9 / Cuves 1/9  Doble carril de botellas / Double bottle lane / Double rail à bouteilles	

Serie / Series / Série **BARSTATION**

+Info: [www.infrico.com](http://www.infrico.com)



Los datos técnicos están sujetos a posibles variaciones que serán actualizadas periódicamente en las fichas técnicas del producto, disponibles en la web /  
The technical data are subject to possible variations that will be updated periodically in the technical data sheets of the product, which are available on the website /  
Les données techniques peuvent varier et seront actualisées dans les fiches techniques du produit, disponibles sur le site web.

# Mesa refrigeración y congelación Euronorma 600x400 pastelería / Euronorm 600x400 refrigerator and freezer counter / Tour pâtissier positif et négatif Euronorme 600x400

EURONORM 600x400

MODELO  
MODELE  
MODÈLE



MR 1620

MR 2190

MR 2750

MR 1620 BT

MR 2190 BT

Precio Price Prix							
Medidas Measures (mm) Mesures	↔ ↗ ↕	1618 x 800 x 850 mm.	2185 x 800 x 850 mm.	2752 x 800 x 850 mm.	1618 x 800 x 850 mm.	2185 x 800 x 850 mm.	
Temperatura Temperature Température	[°C]	-2°C/+8°C			-18°C		
Clase Climática Climatic class Classe climatique	[°C]	5 / 40°C			4 / 38°C		
Tensión/Frecuencia Electrical data Tension électrique		230V/1ph/50Hz					
Controlador Controller Régulateur		Digital IP65					
Material Material (EXT/INT) Matériel		Inox AISI 304					
Espesor Thickness Épaisseur	(mm)	70					
Aislamiento Isolation Isolation	(mm)	40kg/m <sup>3</sup> / Free CFC's / Zero ODP-GWP					
Capacidad Capacity Capacité	[L]	420	635	850	420	635	
Puertas Doors Portes		2	3	4	2	3	
Nº parrillas / Guías Nº shelves / Slides Nº de grilles / Glissière		2/10 [600x400]	3/15 [600x400]	4/20 [600x400]	2/10 [600x400]	3/15 [600x400]	
Sistema de frío Cooling System Système de froid		Monoblock ventilado / Forced air monoblock / Monoblock ventilé					
Desescarche Defrost Dégivrage		Parada compresor / Compressor off / Arrêt du compresseur			Gas caliente / Hot gas defrost / Gaz chaud		
Expansión Expansion Expansion		Capilar / Capillary / Capillaire			Válvula de expansión termostática / Thermostatic expansion valve / Détendeur thermostatique		
Potencia Power Puissance	[W]	368			568	712	
Potencia frig. Cooling capacity Puissance Frig.	[W A -10°C]	690			540	639	
Consumo Consumption Consommation	[kWh/ 24h]	1,67	2,07	3,06	6,03	11,15	
Clase energética Energy class Classe Énerg.		<b>A</b>		<b>B</b>	<b>C</b>	<b>D</b>	
Refrigerante Refrigerant Gaz		<b>R-290</b>					
Opcional Optional Options		Granito / Granite-top / Granit MR1620 [1618X800X30] [606X35] Granito / Granite-top / Granit MR2190 [2185X800X30] [606X36] Granito / Granite-top / Granit MR2750 [2752X800X30] [606X37] Bandeja Inox/ Stainless Steel Tray / Bac Inox 600x400 [A850P41] Cerradura / Lock / Serrure [506X209; 506X210]			Parrilla / Wire shelf / Grille [502X26] Juego de guías / Slides / Jeu de Glissières [GUIAL0120641, GUIAL0220641] Ruedas / Casters / Roulettes [705X16=2; 705X17=2]		
		115V/1ph/60Hz 230V/1ph/60Hz			115V/1ph/60Hz 230V/1ph/60Hz		

Serie / Series / Série **800**

+Info: [www.infrico.com](http://www.infrico.com)

MR 2750



MR 2190 BT

Opcional  
Optional  
Option



Controlador digital IP 65.  
Digital control IP65  
Contrôleur digital IP 65.

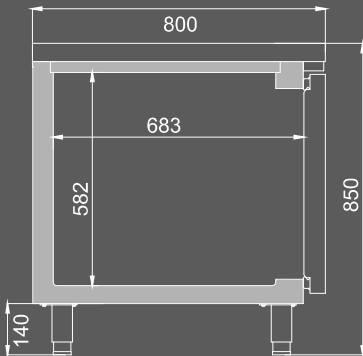

**Frío Ventilado con efecto estático para pastelería profesional**  
Ventilated cooling with static effect for professional patisseries  
Refroidissement ventilé avec effet statique pour les pâtisseries professionnelles



Opcional: Manejo control digital por WiFi o Bluetooth®  
Optional: Operating digital control by WiFi or Bluetooth®

Opcional granito  
Optional granite worktop  
Option granite



**Mesa refrigeración 600x400 puerta cristal /**  
**600x400 glass door counter refrigerator /**  
**Tour pâtissier positif 600x400 porte vitrée**

**Mesa refrigeración 600x400 remota /**  
**600x400 remote counter refrigerator /**  
**Tour pâtissier positif 600x400 groupe à distance**

Grupo remoto / Remote / Groupe à distance

MODELO  
 MODELE  
 MODÈLE



MR 1620 CR

MR 2190 CR

MR 2750 CR

MR 1620 GR

MR 2190 GR

MR 2750 GR

	MR 1620 CR	MR 2190 CR	MR 2750 CR	MR 1620 GR	MR 2190 GR	MR 2750 GR
<b>Precio</b> Price Prix						
<b>Medidas</b> Measures (mm) Mesures	1618 x 800 x 850 mm.	2185 x 800 x 850 mm.	2752 x 800 x 850 mm.	1390 x 800 x 850 mm.	1957 x 800 x 850 mm.	2524 x 800 x 850 mm.
<b>Temperatura</b> Temperature Température		+2°C/+6°C.			-2°C/+8°C.	
<b>Clase Climática</b> Climatic class Classe climatique		4 / 36°C.			5 / 40°C.	
<b>Tensión/Frecuencia</b> Electrical data Tension électrique	230V/1ph/50Hz					
<b>Controlador</b> Controller Régulateur	Digital IP65					
<b>Material</b> Material (EXT/INT) Matériel	Inox AISI 304					
<b>Espesor</b> Thickness Épaisseur	70					
<b>Aislamiento</b> Isolation Isolation	40kg/m <sup>3</sup> / Free CFC's / Zero ODP-GWP					
<b>Capacidad</b> Capacity Capacité	420	635	850	420	635	850
<b>Puertas</b> Doors Portes	2	3	4	2	3	4
<b>N° parrillas / Guías</b> N° shelves / Slides N° de grilles / Glissière	2/10 (600x400)	3/15 (600x400)	4/20 (600x400)	2/10 (600x400)	3/15 (600x400)	4/20 (600x400)
<b>Sistema de frío</b> Cooling System Système de froid	Monoblock ventilado / Forced air monoblock / Monoblock ventilé			-		
<b>Desescarche</b> Defrost Dégivrage	Parada compresor / Compressor off / Arrêt du compresseur					
<b>Expansión</b> Expansion Expansion	Capilar / Capillary / Capillaire			Válvula expansión opcional (especificar refriger.) Expansion valve optional (specify refriger.) Détendeur options (spécifier le gaz)		
<b>Potencia</b> Power Puissance	378	383	389	368		
<b>Potencia frig.</b> Cooling capacity Puissance Frig.	690			Recom. 690		
<b>Consumo</b> Consumption Consommation	-			-		
<b>Clase energética</b> Energy class Classe Énerg.	-			-		
<b>Refrigerante</b> Refrigerant Gaz	R-290			-		
<b>Opcional</b> Optional Options	Juego de guías / Slides / Jeu de Glissières (GUIAL0120641, GUIAL0220641)					
	Parrilla doble tupida / Extradense wire shelf / Grille renforcée [502X64] Granito / Granite-top / Granit MR1620 [1618X800X30] [606X35] Granito / Granite-top / Granit MR2190 [2185X800X30] [606X36] Granito / Granite-top / Granit MR2750 [2752X800X30] [606X37] Cerradura / Lock / Serrure [506X60] Parrilla Inox / Stainless steel wire shelf / Grille inox [502X47] Bandeja Inox / Stainless Steel Tray / Bac Inox 600x400 [A850P41] Iluminación Led RGB con cambio de color (por puerta) / Led lighting RGB change of colour (per door) / LED RGB avec changement de couleur (par porte)			Parrilla / Wire shelf / Grille [502X26] Puerta de cristal / Glass door / Porte vitrée [PUE17IDMR-PUE17IIMR] Cerradura / Lock / Serrure [506X209; 506X210] Bandeja Inox / Stainless Steel Tray / Bac Inox 600x400 [A850P41] Válvula expansión opcional (especificar refriger.) Expansion valve optional (specify refriger.) Détendeur options (spécifier le gaz)		

Serie / Series / Série **800**

+Info: [www.infrico.com](http://www.infrico.com)



**Posibilidad de acceso frontal y lateral para una mejor manipulación**  
 Front and lateral access for better handling  
 Possibilité d'accès frontal et latéral pour une meilleure manipulation.

**Aumentan en su largo 8 cm. para una mejor manipulación.**

They increase in their length 8 cm. for better handling.

8 cm. de long en plus pour une meilleure manipulation.



MR 2190 GR

**Doble cristal templado bajo emisivo más carga Argón 4-27-4**

Double tempered glass low-e + Argón 4-27-4

Double vitrage trempé à faible émissivité avec Argón 4-27-4



**Opcional granito**  
 Optional granite worktop  
 Option granite

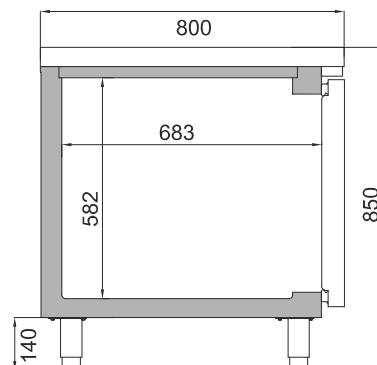

**Mesa refrigerada central  
600x400 puerta dos caras /  
600x400 pass thru counter refrigerator /  
Tour pâtissier positif 600x400 traversante**

**Mesa refrigerada 600x400 para ensaladas,  
pizza y pastelería / 600x400 salads, pizza and  
pastry prep counter refrigerator / Table positive  
600x400 préparation salades, pizzas et pâtisseries**

EURONORM 600x400

Pasante/Pass-thru/Traversante

EURONORM 600x400

Ensalada, pizza y pastelería  
Salads, pizza & pastry  
Salade, pizza et pâtisserie

MODELO  
MODELE  
MODÈLE

MR 1620 PDC

MR 2190 PDC

MR 1620 PDCR

MR 2190 PDCR

MR 1620 EN

MR 2190 EN

<b>Precio</b> Price Prix						
<b>Medidas</b> Measures (mm) Mesures	1618 x 800 x 850 mm.	2185 x 800 x 850 mm.	1618 x 800 x 850 mm.	2185 x 800 x 850 mm.	1618 x 800 x 850/1050 mm.	2185 x 800 x 850/1050 mm.
<b>Temperatura</b> Temperature Température	-2°C/+8°C		+2°C/+6°C		0°C/+6°C	
<b>Clase Climática</b> Climatic class Classe climatique	5 / 40°C		4 / 38°C		4 / 38°C	
<b>Tensión/Frecuencia</b> Electrical data Tension électrique	230V/1ph/50Hz					
<b>Controlador</b> Controller Régulateur	Digital IP65					
<b>Material</b> Material (EXT/INT) Matériel	Inox AISI 304					
<b>Espesor</b> Thickness Épaisseur	70					
<b>Aislamiento</b> Isolation Isolation	40kg/m <sup>3</sup> / Free CFC's / Zero ODP-GWP					
<b>Capacidad</b> Capacity Capacité	420	635	420	635	420+55	635+80
<b>Puertas</b> Doors Portes	4	6	4	6	2	3
<b>N° parrillas / Guías</b> N° shelves / Slides N° de grilles / Glissière	2/10 (600x400)	3/15 (600x400)	2/10 (600x400)	3/15 (600x400)	2/10 (600x400)	3/15 (600x400)
<b>Sistema de frío</b> Cooling System Système de froid	Monoblock ventilado / Forced air monoblock / Monoblock ventilé					
<b>Desescarche</b> Defrost Dégivrage	Parada compresor / Compressor off / Arrêt du compresseur					
<b>Expansión</b> Expansion Expansion	Capilar / Capillary / Capillaire					
<b>Potencia</b> Power Puissance	368		387		398	
<b>Potencia frig.</b> Cooling capacity Puissance Frig.	690					
<b>Consumo</b> Consumption Consommation	1,67	2,07	-			
<b>Clase energética</b> Energy class Classe Énerg.	A		A		-	
<b>Refrigerante</b> Refrigerant Gaz	R-290					
<b>Opcional</b> Optional Options	Parrilla / Wire shelf / Grille [502X26] Bandeja Inox / Stainless Steel Tray / Bac Inox 600x400 [A850P41] Juego de guías / Slides / Jeu de Glissières [GUIAL0120641, GUIAL0220641]			Cerradura / Lock / Serrure [506X209; 506X210]		
	Parrilla doble tupida / Extradense wire shelf / Grille renforcée [502X64] Granito / Granite-top / Granit MR1620 [1618X800X30] [606X35] Granito / Granite-top / Granit MR2190 [2185X800X30] [606X36] Cerradura / Lock / Serrure [506X60] [PDCR] Parrilla Inox / Stainless steel wire shelf / Grille inox [502X47]				Parrilla de trabajo / Garnish rack / Grille travail [PTMP] Ruedas / Casters / Roulettes [705X16=2; 705X17=2]	
					[501X16] = 9	[501X16] = 13

Serie / Series / Série **800**

+Info: [www.infrico.com](http://www.infrico.com)

Opcional  
Optional  
Option

Pasante/Pass-thru/Traversante  
**MR 2190 PDC**



Pasante/Pass-thru/Traversante  
**MR PDC**

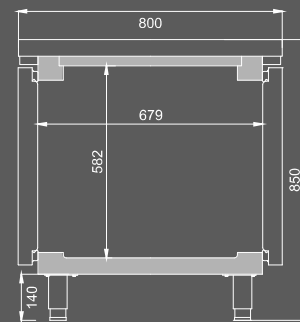

[501X16] = 9



[501X16] = 13

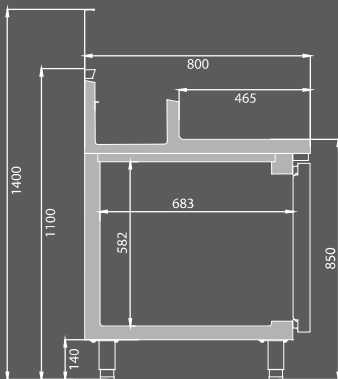

**MR 1620 EN**

Refrigeración estática en la cuba  
Static cooling in the tank  
Refrondissement statique





## Mesa refrigerada ventilada con control de humedad / Ventilated refrigerated table with humidity control / Table réfrigérée ventilée avec contrôle de l'humidité

MODELO  
MODELE  
MODÈLE



MR 1620 H



MR 2190 H

	MR 1620 H	MR 2190 H
<b>Precio</b> Price Prix		
<b>Medidas</b> Measures (mm) Mesures	1618 x 800 x 850 mm.	2185 x 800 x 850 mm.
<b>Temperatura</b> Temperature Température	+2°C/+8°C	
<b>Clase Climática</b> Climatic class Classe climatique	4 / 38°C	
<b>Tensión/Frecuencia</b> Electrical data Tension électrique	230V/1ph/50Hz	
<b>Controlador</b> Controller Régulateur	Digital IP65 con control de humedad / Digital IP65 with humidity control / Digital IP65 avec contrôle de l'humidité	
<b>Material</b> Material (EXT/INT) Matériel	Inox AISI 304	
<b>Espesor</b> Thickness Épaisseur	70	
<b>Aislamiento</b> Isolation Isolation	40kg/m <sup>3</sup> / Free CFC's / Zero ODP-GWP	
<b>Capacidad</b> Capacity Capacité	420	635
<b>Puertas</b> Doors Portes	2	3
<b>N° parrillas / Guías</b> N° shelves / Slides N° de grilles / Glissière	2/10 (600x400)	3/15 (600x400)
<b>Sistema de frío</b> Cooling System Système de froid	Monoblock ventilado / Forced air monoblock / Monoblock ventilé	
<b>Desescarche</b> Defrost Dégivrage	Parada compresor / Compressor off / Arrêt du compresseur	
<b>Expansión</b> Expansion Expansion	Capilar / Capillary / Capillaire	
<b>Potencia</b> Power Puissance	868	
<b>Potencia frig.</b> Cooling capacity Puissance Frig.	690	
<b>Consumo</b> Consumption Consommation	-	-
<b>Clase energética</b> Energy class Classe Énerg.	-	
<b>Refrigerante</b> Refrigerant Gaz	<b>R-290</b>	
<b>Opcional</b> Optional Options	Granito / Granite-top / Granit MR1620 [1618X800X30] [606X35] Granito / Granite-top / Granit MR2190 [2185X800X30] [606X36] Bandeja Inox/ Stainless Steel Tray / Bac Inox 600x400 [A850P41] Cerradura / Lock / Serrure [506X209; 506X210] 115V/1ph/60Hz 230V/1ph/60Hz	Parrilla / Wire shelf / Grille [502X26] Juego de guías / Slides / Jeu de Glissières [GUIAL0120641, GUIAL0220641] Ruedas / Casters / Roulettes [705X16=2; 705X17=2]

Serie / Series / Série **MR H**

+Info: [www.infrico.com](http://www.infrico.com)

**Control electrónico de Temperatura y Humedad**  
Electronic Temperature and Humidity control  
Contrôle électronique de la Température et de l'humidité



**Opcional granito**  
Optional granite worktop  
Option granite



MR 1620 H



MR 2190 H



**Mesa refrigerada  
pizza Lucena /  
Pizza prep table Lucena /  
Table positive et fast  
food Lucena  
(MPL)**

**Mesa refrigerada pizza /  
Pizza prep table /  
Table positive pizza  
(MP)**

MODELO  
MODELE  
MODÈLE



MPL 1740



MPL 2300



MP 1740



MP 2300



MP 1740 CN



MP 2300 CN

<b>Precio</b> Price Prix											
<b>Medidas</b> Measures (mm) Mesures	↔ ↕	1693 x 800 x 850/1010 mm.	2260 x 800 x 850/1010 mm.	1738 x 800 x 830/980 mm.	2305 x 800 x 830/980 mm.	1738 x 800 x 830/980 mm.	2305 x 800 x 830/980 mm.				
<b>Temperatura</b> Temperature Température	[°C]	<b>+2°C/+6°C</b>									
<b>Clase Climática</b> Climatic class Classe climatique	[°C]	4 / 38°C			5 / 40°C						
<b>Tensión/Frecuencia</b> Electrical data Tension électrique		230V/1ph/50Hz									
<b>Controlador</b> Controller Régulateur		Digital IP65									
<b>Material</b> Material (EXT/INT) Matériel		Inox AISI 304									
<b>Espesor</b> Thickness Épaisseur	[mm]	55									
<b>Aislamiento</b> Isolation Isolation	[mm]	40kg/m <sup>3</sup> / Free CFC's / Zero ODP-GWP									
<b>Capacidad</b> Capacity Capacité	[L]	485	700	485+48	700+70	(R) 235 (V) 48 (N) 175	(R) 485 (V) 70 (N) 175				
<b>Puertas</b> Doors Portes		2	3	2	3	1 + Neutro	2 + Neutro				
<b>N° parrillas / Guías</b> N° shelves / Slides N° de grilles / Glissière		2/10 [600x400]	3/15 [600x400]	7 [600x400]	10 [600x400]	8 [600x400]	11 [600x400]				
<b>Sistema de frío</b> Cooling System Système de froid		Ventilado / Forced air / Ventilé									
<b>Desescarche</b> Defrost Dégivrage		Parada compresor / Compressor off / Arrêt du compresseur									
<b>Expansión</b> Expansion Expansion		Capilar / Capillary / Capillaire									
<b>Potencia</b> Power Puissance	[W]	368		553		350		553			
<b>Potencia frig.</b> Cooling capacity Puissance Frig.	[W A -10°C]	690		690		370		690			
<b>Refrigerante</b> Refrigerant Gaz		<b>R-290</b>									
<b>Opcional</b> Optional Options		Parrilla/Wire shelf/Grille [502X26] Juego de guías/Slides/Jeu de Glissières [GUAL0120641; GUAL0220641] Parrilla de trabajo / Garnish rack / Grille travail [PTMT] [MPL1740-3UD] [MPL2300-4UD] Cerradura / Lock / Serrure [506X209; 506X210] Ruedas / Casters / Roulettes [705X16=2; 705X17=2]			Parrilla/Wire shelf/Grille [502X26] Juego de guías/Slides/Jeu de Glissières [GUAL0120641; GUAL0220641] Opción neutro 6 cajones / Optional 6 drawers dry store / En option kit 6 tiroirs neutres [JCAJ17MP6] (Sólo / Only / Seulement MP2300CN) Contenedor polipropileno / Polypropylene container / Container polypropylène [501X08] Cerradura / Lock / Serrure [506X209; 506X210] 115V/1ph/60Hz 230V/1ph/60Hz						
		{501X14} = 1 {501X11} = 5 {501X10} = 4	{501X14} = 1 {501X11} = 8 {501X10} = 4	{501X13} = 1 {501X16} = 5	{501X13} = 1 {501X16} = 9	{501X13} = 1 {501X16} = 5	{501X13} = 1 {501X16} = 9				

Serie / Series / Série **800**

+Info: [www.infrico.com](http://www.infrico.com)

**IMPORTANTE:** Las bandejas deben contener producto previamente refrigerado.  
**IMPORTANT:** The trays should contain previously refrigerated product.  
**IMPORTANT:** Les plateaux doivent contenir des produits préalablement réfrigérés.

[501X14] = 1 [501X11] = 8 [501X10] = 4



[501X14] = 1 [501X11] = 5 [501X10] = 4

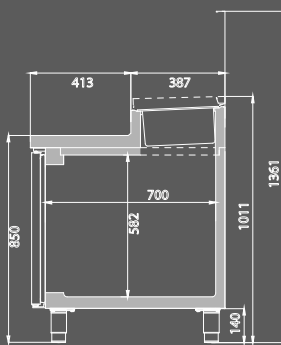

MPL 2300

Parrillas de trabajo  
Garnish racks  
Grilles de travail

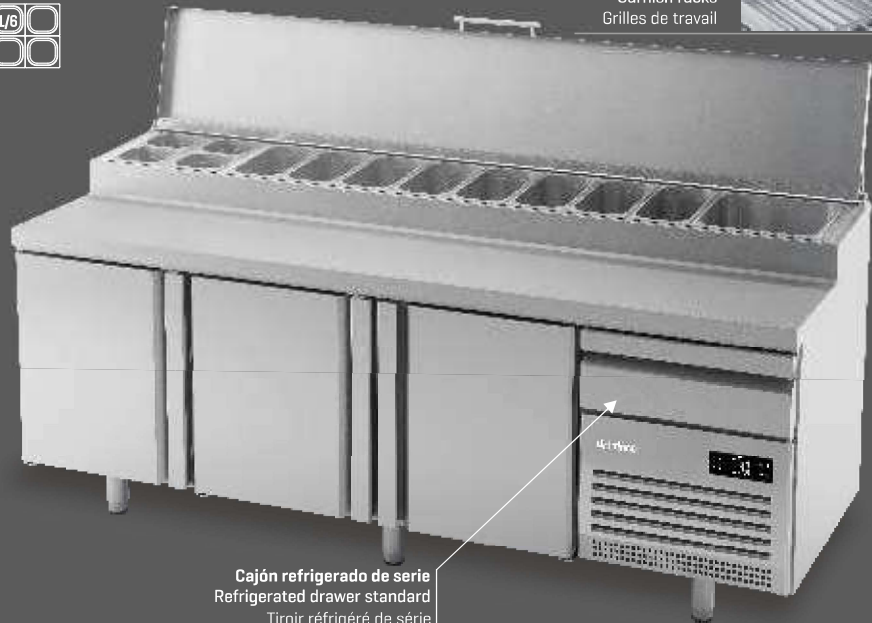
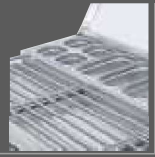

Cajón refrigerado de serie  
Refrigerated drawer standard  
Tiroir réfrigéré de série

[501X13] = 1 [501X16] = 9



[501X13] = 1 [501X16] = 5



Vídeo del producto

Product Video

Vidéo du produit



Infrico Youtube



Internet of things

Opcional: Manejo control digital por WiFi o Bluetooth®

Optional: Operating digital control by WiFi or Bluetooth®

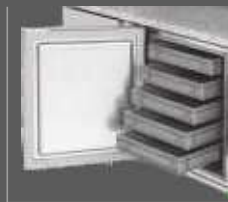

Vitrina de ingredientes incluida  
Included ingredients display  
De série vitrine avec couvercle vitré

MP 2300 CN

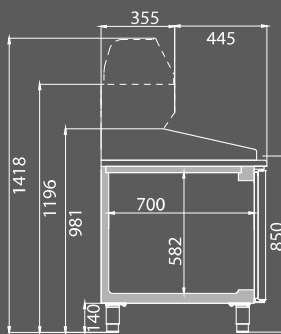

Opcional kit neutro 6 cajones  
Optional 6 neutral drawers  
En option kit 6 tiroirs neutres



Cajón refrigerado de serie  
Refrigerated drawer standard  
Tiroir réfrigéré de série

**Frente mostrador /**  
**Back-bar counter refrigerator /**  
**Desserte arrière bar positive cafétéria**

**Frente mostrador refrigerado preinstalado /**  
**Remote back-bar counter refrigerator /**  
**Desserte arrière bar groupe à distance cafétéria**



MODELO  
 MODELE  
 MODÈLE



Preinstalado / Remote / À distance

	FMPP1500 II	FMPP2000 II	FMPP2500 II	FMPP1500 CR	FMPP2000 CR	FMPP2500 CR	FMPP1500 GR	FMPP2000 GR	FMPP2500 GR
<b>Precio</b> Price Prix									
<b>Medidas</b> Measures (mm) Mesures	1468 x 600 x 1050 mm.	1960 x 600 x 1050 mm.	2452 x 600 x 1050 mm.	1468 x 600 x 1050 mm.	1960 x 600 x 1050 mm.	2452 x 600 x 1050 mm.	1240 x 600 x 1050 mm.	1732 x 600 x 1050 mm.	2224 x 600 x 1050 mm.
<b>Temperatura</b> Temperature Température	-2°C/+8°C			+2°C/+6°C			0°C/+6°C		
<b>Clase Climática</b> Climatic class Classe climatique	5 / 40°C			4 / 38°C			-		
<b>Tensión/Frecuencia</b> Electrical data Tension électrique	230V/1ph/50Hz								
<b>Controlador</b> Controller Régulateur	Digital IP65								
<b>Material</b> Material (EXT/INT) Matériel	Inox AISI 304								
<b>Espesor</b> Thickness Épaisseur	70								
<b>Aislamiento</b> Isolation Isolation	40kg/m <sup>3</sup> / Free CFC's / Zero ODP-GWP								
<b>Capacidad</b> Capacity Capacité	340	520	690	340	520	690	340	520	690
<b>Puertas</b> Doors Portes	2	3	4	2	3	4	2	3	4
<b>N° parrillas / Guías</b> N° shelves / Slides N° de grilles / Glissière	4/4 (325x430)	6/6 (325x430)	8/8 (325x430)	4/4 (325x430)	6/6 (325x430)	8/8 (325x430)	4/4 (325x430)	6/6 (325x430)	8/8 (325x430)
<b>Sistema de frío</b> Cooling System Système de froid	Monoblock ventilado / Forced air monoblock / Monoblock ventilé						-		
<b>Desescarche</b> Defrost Dégivrage	Parada compresor / Compressor off / Arrêt du compresseur								
<b>Expansión</b> Expansion Expansion	Capilar / Capillary / Capillaire						Válvula expansión opcional [especificar refriger.] Expansion valve optional [specify refriger.] Détendeur options [spécifier le gaz]		
<b>Potencia</b> Power Puissance	209	308		377	382	387	-		
<b>Potencia frig.</b> Cooling capacity Puissance Frig.	370	690				Recom. 370		Recom. 690	
<b>Consumo</b> Consumption Consommation	1,55	2,06	2,35	-					
<b>Clase energética</b> Energy class Classe Énerg.	<b>A</b>	<b>A</b>	<b>A</b>	-					
<b>Refrigerante</b> Refrigerant Gaz	<b>R-290</b>								
<b>Opcional</b> Optional Options	Juego de guías / Slides / Jeu de Glissières [GUIAC0115430, GUIAC0215430] Parrilla doble tupida / Extradense wire shelf / Grille renforcée [502X43] Parrilla inoxidable / Stainless steel wire shelf / Grille Inox [502X49] Iluminación Led RGB con cambio de color (por puerta) / Led lighting RGB change of colour (per door) / LED RGB avec changement de couleur (par porte)						Parrilla / Wire shelf / Grille [502X07] Cerradura / Lock / Serrure [506X209; 506X210] Cerradura / Lock / Serrure [506X60] (Mod. CR)		
	Kit cajones / Drawer Kit / Kit tiroirs FM 350 + FM 250 [JCAJ17FM3525] BM 2 x 1/2x200 + 1 x 1/3x100 [JCAJ17FM1/2] BM 2/3 x 300 [JCAJ17FM2/3]						- Kit cajones / Drawer Kit / Kit tiroirs FM 350 + FM 250 [JCAJ17FM3525] BM 2 x 1/2x200 + 1 x 1/3x100 [JCAJ17FM1/2] BM 2/3 x 300 [JCAJ17FM2/3]		
	Tolva / Coffe grounds hopper / Tiroir marc à café [TOL17FM] Grupo lado contrario / Group opposite side / Groupe opposé [L]						Válvula expansión opcional [especificar refriger.] Expansion valve optional [specify refriger.] Détendeur options [spécifier le gaz]		

Serie / Series / Série **600**

+Info: [www.infrico.com](http://www.infrico.com)

FMPP 2000 GR



22cm

**Posibilidad de acceso frontal y lateral para una mejor manipulación.**

Front and lateral access for better handling.  
Possibilité d'accès frontal et latéral pour une meilleur manipulation.

**Controlador digital IP 65.**  
Digital control IP65  
Contrôleur digital IP 65.



FMPP 2000 CR



**Tolva Opcional**  
Coffe grounds hopper Optional  
Tiroir marc à café Options

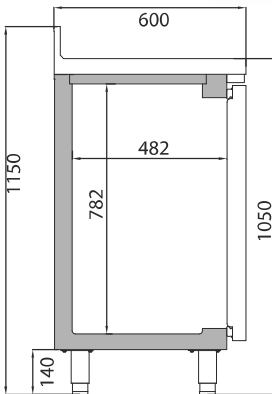

<b>FM 250</b> 302 x 418 x 255	<b>1/3</b> 302 x 418 x 105	
<b>FM 350</b> 302 x 418 x 352	<b>1/2</b> 302 x 418 x 205	<b>2/3</b> 302 x 418 x 307

<b>Kit 2 cajones</b> 2 drawers kit Kit 2 tiroirs	<b>Kit 3 cajones</b> 3 drawers kit Kit 3 tiroirs	<b>Kit 2 cajones</b> 2 drawers kit Kit 2 tiroirs
FM 350 + FM 250	2 x BM 1/2 x 200 1 x BM 1/3 x 100	BM 2 x 2/3 x 300

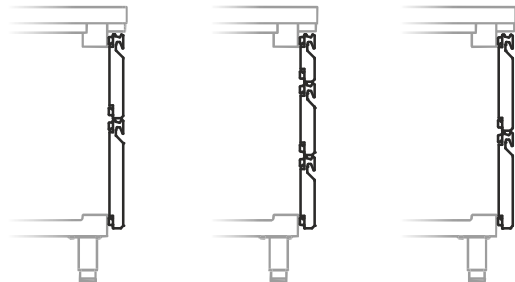
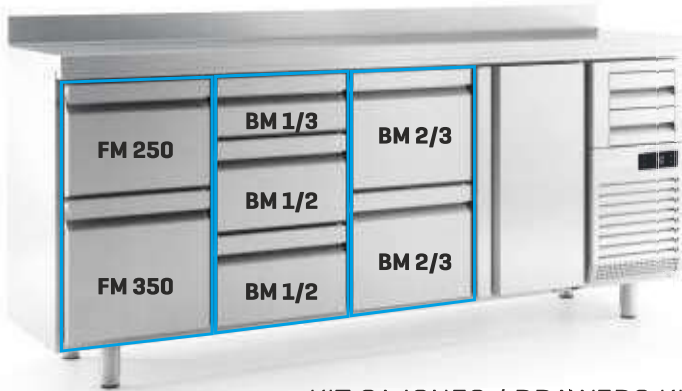

**KIT CAJONES / DRAWERS KIT / KIT TIROIRS (MOD. II - GR)**

**Mueble mesa cafetera /**  
**Coffe unit /**  
**Meuble cafétéria**

**Serie / Series / Série MCAF**



MODELO MODELE MODÈLE	MCAF 820	MCAF 1000 CD	MCAF 1000 CI	MCAF 1500	MCAF 2000	MCAF 2500
Precio Price Prix						
Medidas Measures (mm) Mesures	820 x 600 x 1050 mm.	1000 x 600 x 1050 mm.	1000 x 600 x 1050 mm.	1468 x 600 x 1050 mm.	1960 x 600 x 1050 mm.	2450 x 600 x 1050 mm.
Material Material Matériel	Inox AISI 304					
Opcional Optional Options	Posibilidad de fabricar a medida sin modificar fondo ni cuerpo central. Possibility of custom-made manufacturing without modifying the depth or central body. Possibilité de fabriquer sur mesure sans modifier ni la profondeur ni la partie centrale.					

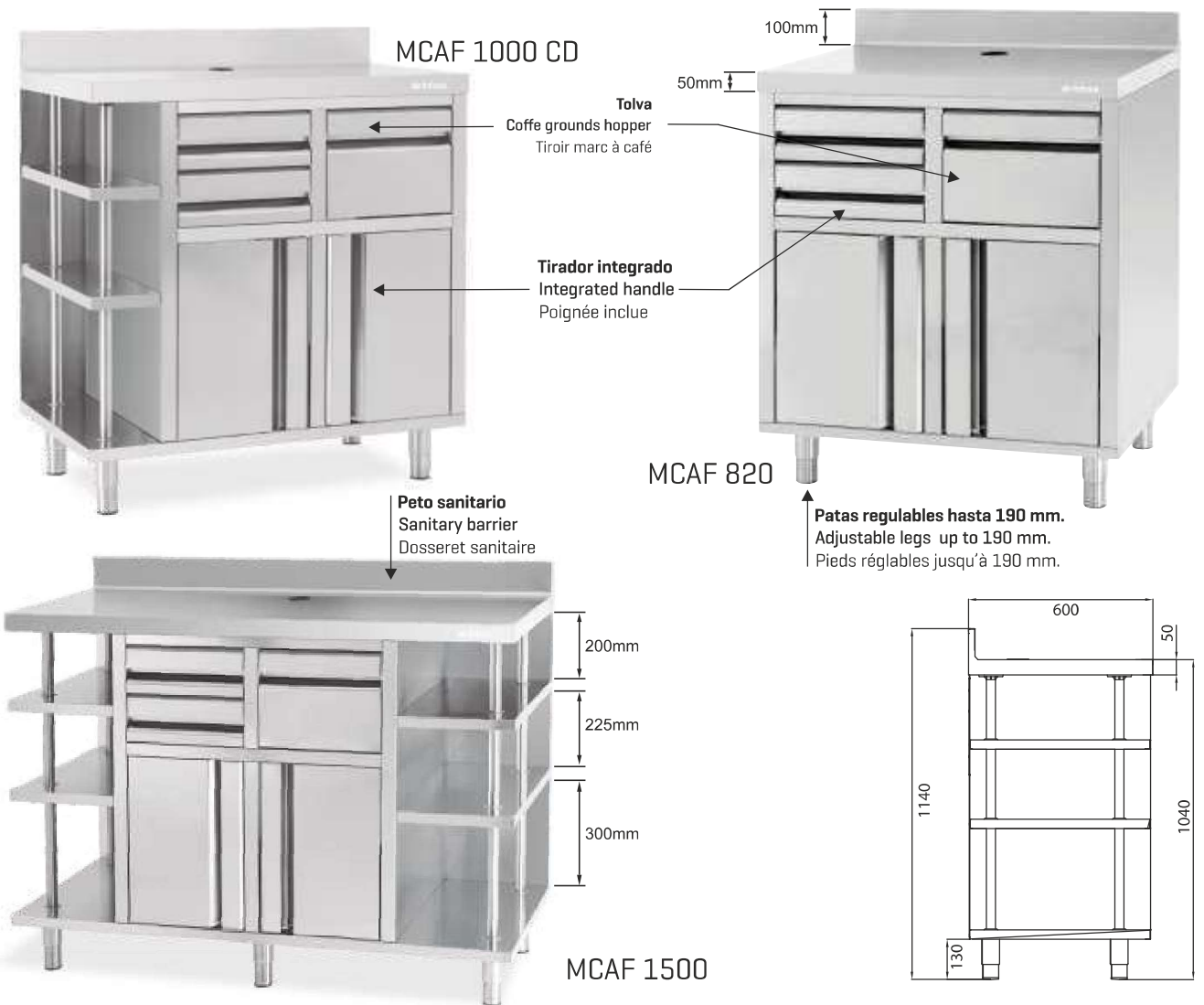

**Mueble estantería y mesa de trabajo /**  
**Shelf unit and working table /**  
**Meuble étagère et table de travail**

+Info: [www.infrico.com](http://www.infrico.com)

**Serie / Series / Série ME / MT**

MUEBLE ESTANTERÍA / SHELF UNIT / MEUBLE ÉTAGÈRE

MODELO MODELE MODÈLE								
	ME 30/1000	ME 30/1500	ME 30/2000	ME 30/2500	ME 60/1000	ME 60/1500	ME 60/2000	ME 60/2500
Precio Price Prix								
Medidas Measures (mm) Mesures	1000 x 300 x 1050mm.	1468 x 300 x 1050mm.	1960 x 300 x 1050mm.	2452 x 300 x 1050mm.	1000 x 600 x 1050mm.	1468 x 600 x 1050mm.	1960 x 600 x 1050mm.	2452 x 600 x 1050mm.
	MESA DE TRABAJO / WORKING TABLE / TABLE DE TRAVAIL							
MODELO MODELE MODÈLE								
	MT 60/1000	MT 60/1500	MT 60/2000	MT 70/1000	MT 70/1500	MT 70/2000		
Precio Price Prix								
Medidas Measures (mm) Mesures	1000 x 600 x 850mm.	1500 x 600 x 850mm.	2000 x 600 x 850mm.	1000 x 700 x 850mm.	1500 x 700 x 850mm.	2000 x 700 x 850mm.		
Material Material [EXT/INT] Matériel	Inox AISI 304							
Opcional Optional Options	Cajón auxiliar / Additional drawer / Tiroir 600 [CAJMT60] <b>137 €</b> Cajón auxiliar / Additional drawer / Tiroir 700 [CAJMT70] <b>147 €</b> Incremento peto mural / Increase for splash blak / Supplément dossieret mod. 1000 <b>54 €</b> Incremento peto mural / Increase for splash blak / Supplément dossieret mod. 1500 <b>79 €</b> Incremento peto mural / Increase for splash blak / Supplément dossieret mod. 2000 <b>96 €</b>							
	Modelos ME / ME Models / Modèles ME: Medidas especiales consultar con fábrica / Special length measurements consult our factory / Dimensions spéciales en longueur consulter l'usine.							

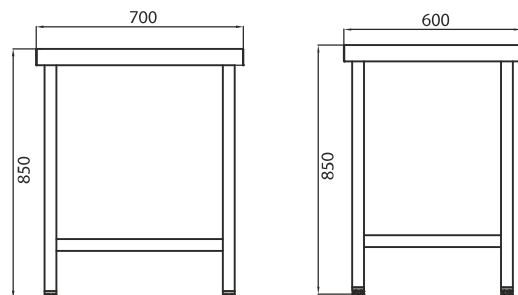
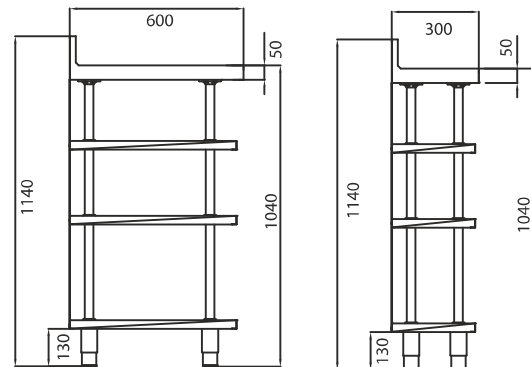



PHOTOBOOK

2



+Info: [www.infrico.com](http://www.infrico.com)

